

Panasonic®

Operating Instructions

Digital Camera

Model No. **DMC-FZ30PP**

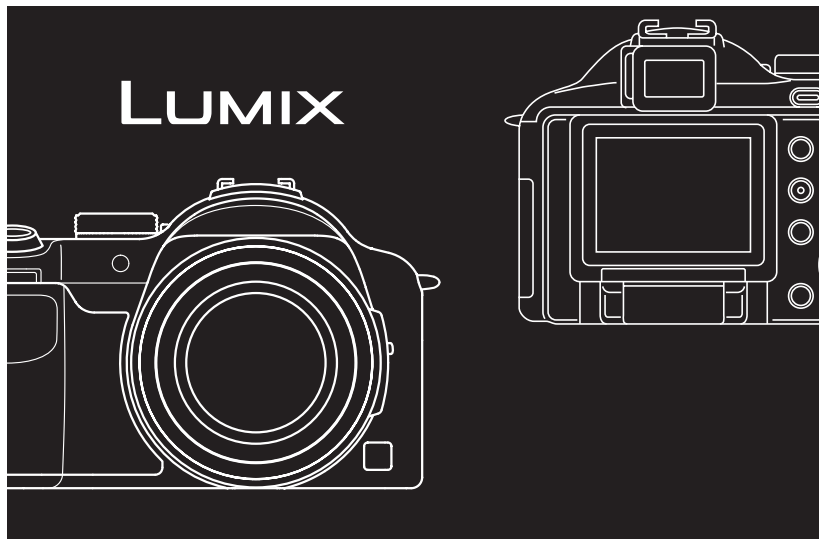
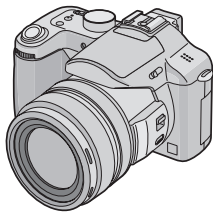

LEICA
DC VARIO-ELMARIT

Before connecting, operating or adjusting this product, please read the instructions completely.

For USA assistance, please call: 1-800-272-7033 or send e-mail to : digitalstillcam@panasonic.com

For Canadian assistance, please call: 1-800-561-5505 or visit us at www.panasonic.ca

VQT0R81

Before Use

Dear Customer,

We would like to take this opportunity to thank you for purchasing this Panasonic Digital Camera. Please read these Operating Instructions carefully and keep them handy for future reference.

Information for Your Safety

WARNING

TO REDUCE THE RISK OF FIRE OR SHOCK HAZARD AND ANNOYING INTERFERENCE, USE ONLY THE RECOMMENDED ACCESSORIES AND DO NOT EXPOSE THIS EQUIPMENT TO RAIN OR MOISTURE. DO NOT REMOVE THE COVER (OR BACK); THERE ARE NO USER SERVICEABLE PARTS INSIDE. REFER SERVICING TO QUALIFIED SERVICE PERSONNEL.

Carefully observe copyright laws.

Recording of pre-recorded tapes or discs or other published or broadcast material for purposes other than your own private use may infringe copyright laws. Even for the purpose of private use, recording of certain material may be restricted.

- Please note that the actual controls and components, menu items, etc. of your Digital Camera may look somewhat different from those shown in the illustrations in these Operating Instructions.
- SD Logo is a trademark.
- Other names, company names, and product names printed in these instructions are trademarks or registered trademarks of the companies concerned.

THE SOCKET OUTLET SHALL BE INSTALLED NEAR THE EQUIPMENT AND SHALL BE EASILY ACCESSIBLE.

CAUTION

Danger of explosion if battery is incorrectly replaced. Replace only with the same or equivalent type recommended by the manufacturer. Dispose of used batteries according to the manufacturer's instructions.



A lithium ion/polymer battery that is recyclable powers the product you have purchased. Please call 1-800-8-BATTERY for information on how to recycle this battery.

Before Use

FCC Note: (U.S. only)

This equipment has been tested and found to comply with the limits for a Class B digital device, pursuant to Part 15 of the FCC Rules. These limits are designed to provide reasonable protection against harmful interference in a residential installation. This equipment generates, uses, and can radiate radio frequency energy and, if not installed and used in accordance with the instructions, may cause harmful interference to radio communications. However, there is no guarantee that interference will not occur in a particular installation. If this equipment does cause harmful interference to radio or television reception, which can be determined by turning the equipment off and on, the user is encouraged to try to correct the interference by one or more of the following measures:

- Reorient or relocate the receiving antenna.
- Increase the separation between the equipment and receiver.
- Connect the equipment into an outlet on a circuit different from that to which the receiver is connected.
- Consult the dealer or an experienced radio/TV technician for help.

FCC Caution: To assure continued compliance, follow the attached installation instructions and use only shielded interface cables with ferrite core when connecting to computer or peripheral devices.

Any changes or modifications not expressly approved by the party responsible for compliance could void the user's authority to operate this equipment.

Trade Name: Panasonic
Model No.: DMC-FZ30
Responsible party: Panasonic Corporation of North America
One Panasonic Way, Secaucus, NJ 07094
Support Contact: Panasonic Consumer Electronics Company
1-800-272-7033

This device complies with Part 15 of the FCC Rules. Operation is subject to the following two conditions: (1) This device may not cause harmful interference, and (2) this device must accept any interference received, including interference that may cause undesired operation.

This Class B digital apparatus complies with Canadian ICES-003



-If you see this symbol-

Information on Disposal in other Countries outside the European Union

This symbol is only valid in the European Union.

If you wish to discard this product, please contact your local authorities or dealer and ask for the correct method of disposal.



■ Care for the camera

- **Do not shake or cause impact to the camera.** The camera may not be operated normally or recording of pictures may be disabled, or the lens may be damaged.
- **Sand or dust may cause a malfunction of the camera. When you use the camera on a beach etc., take care so that sand or dust does not get into the camera.**
- When you use the camera on a rainy day or on a beach, take care so that water does not get into the camera.
- **If seawater splashes onto the camera, wet a soft cloth with tap water, wring it well, and use it to wipe the camera body carefully. Then, wipe it again with a dry cloth.**

■ About the LCD monitor/Viewfinder

- **Do not press the LCD monitor strongly. It may cause uneven colors on the LCD monitor or a malfunction of the LCD monitor.**
- In a place with drastic temperature changes, condensation may form on the LCD monitor. Wipe it with a soft, dry cloth.
- If the camera is extremely cold when you turn the camera on, the image on the LCD monitor/Viewfinder is slightly darker than usual at first. However, as the internal temperature increases, it goes back to the normal brightness.
- **When rotating the LCD monitor, be careful not to use excessive force. This may result in damage.**
- **Depending on the tripod you are using, you may not be able to rotate the LCD monitor.**
- When not using the LCD monitor or when using the Viewfinder, it is recommended that you close the LCD monitor with the screen facing inwards to prevent dirt and scratches.

Extremely high precision technology is employed to produce the LCD monitor/Viewfinder screen. The result is more than 99.99% effective pixels with a mere 0.01% of the pixels inactive or always lit. However, this will not be recorded on the pictures in the card.

■ **About the Lens**

- Do not direct the lens to the sun or strong light sources. It may cause not only a malfunction of the camera but irreversible damage to your eye.
- Do not press the lens strongly.
- Leaving the camera with the lens facing the sun may cause a malfunction. Be careful when you put the camera outside or near a window.
- When there is dirt (water, oil, and fingerprints, etc.) on the surface of the lens, the picture may be affected. Lightly wipe the surface of the lens with a soft, dry cloth before and after taking pictures.

■ **About Condensation (When the lens or the Viewfinder is fogged up)**

Condensation takes place when the ambient temperature or humidity is changed as follows:

Be careful of condensation since it causes stains on the lens, fungus or malfunction.

- When the camera is brought inside from the cold to a warm room.
- When the camera is moved from outside to an air-conditioned car.
- When cool wind from an air conditioner or other is directly blown onto the camera.
- In humid places

Put the camera into plastic bag until the temperature of the camera is close to the ambient temperature to avoid condensation. In case of condensation, turn the camera off and then leave it for about 2 hours.

When the camera becomes close to the ambient temperature, the fog disappears naturally.

■ **If you will not be using the camera for a long time**

- Store the battery in a cool and dry place with a relatively stable temperature. (Recommended temperature: 15 °C to 25 °C (59 °F to 77 °F), Recommended humidity: 40% to 60%)
- Be sure to remove the battery and the card from the camera.
- When the battery is left inserted in the camera for a long time, discharge takes place even if the camera is turned off. If you leave the battery inserted for an extended period of time, it will be excessively discharged and it may become unusable even after it is charged.
- To store the battery for a long period of time, we recommend charging it once every year and storing it again after you completely use up the charged capacity.
- When you keep the camera in a closet or a cabinet, we recommend storing it with the desiccant (silica gel).
- When storing the camera for long periods of time, it is recommended that you close the LCD monitor with the screen facing inwards.

About These Operating Instructions

■ About indications in these operating instructions



Modes indicated here allow you to use the functions or settings described on this page. Set the Mode dial to any of the modes to use the functions or settings.



Convenient or helpful information for use of the camera is described.

■ About illustrations in these operating instructions

Please note that the appearance of the product, the illustration or the menu screen are a little different from those in actual use.

■ About illustrations of the cursor button

In these operating instructions, the operations on the cursor button are described as illustrated below.

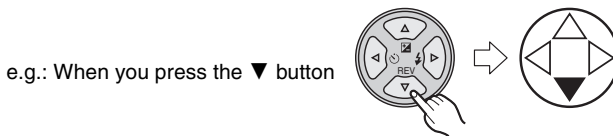

■ About the front dial and rear dial

Instructions for using these dials in the operating instructions are given with illustrations that match the screen icons.

- Rotate the front dial and rear dial slowly but surely.

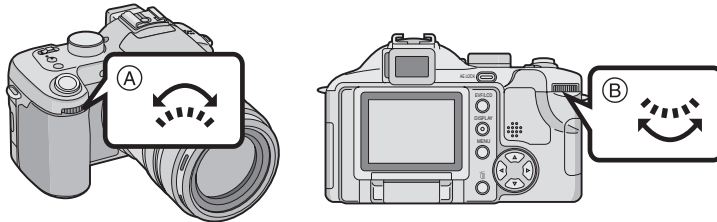

Ⓐ: Front dial

Ⓑ: Rear dial

Contents

Before Use

Information for Your Safety	2
About These Operating Instructions	6

Preparation

Standard Accessories	9
Names of the Components	10
Charging the Battery with the Charger ...	12
About the Battery (Charging/number of recordable pictures)	13
Inserting/Removing the Battery	14
Inserting/Removing the Card	15
About the Card.....	16
Removing the Lens Cap/Attaching the Strap.....	17
Attaching/Removing the Lens Hood	18
Setting Date/Time (Clock Set)	20
About the Setup Menu	21
About the LCD Monitor/Viewfinder	25
Approximate number of recordable pictures and the size	31
About the zoom.....	33
• Using the Optical Zoom	33
• Using the Digital Zoom	34
• Using the extended optical zoom (EZ).....	34

Recording pictures (basic)

The Mode Dial	36
Taking Pictures	37
Taking Pictures in Auto Mode.....	42
Checking the Recorded Picture (Review)	44
Taking Close-up Pictures [AF MACRO]	45
Taking Pictures with Manual Focus	46
Taking Pictures using the Built-in Flash	49
Taking Pictures with the Self-timer	53
Compensating the Exposure	54

Taking Pictures using Auto Bracket	55
Optical Image Stabilizer	56
Taking Pictures using Burst Mode	57

Playback (basic)

Playing Back Pictures	59
Multi Playback (9 screens, 16 screens, and 25 screens)	60
Using the Playback Zoom	61
Deleting Pictures.....	62

Recording pictures (advanced)

Using the Mode Dial	64
• Aperture-priority AE	64
• Shutter-priority AE	65
• Manual exposure	66
• Motion picture mode	69
• [SCENE MODE] menu.....	71
– Portrait mode	72
– Sports mode	72
– Food mode	73
– Scenery mode	73
– Night portrait mode	74
– Night scenery mode.....	74
– Baby mode	75
– Soft skin mode.....	76
– Candle light mode.....	76
– Party mode	77
– Fireworks mode	77
– Snow mode.....	78
– Starry sky mode.....	79
– Panning mode	80

Recording Menu Settings

Using the [REC] mode menu	81
• White Balance [W.BALANCE]	82
• ISO Sensitivity [SENSITIVITY]	84
• Aspect Ratio [ASPECT RATIO]	84
• Picture Size [PICT.SIZE]	85
• Quality [QUALITY]	86
• Audio Recording [AUDIO REC.]	87

- Metering Mode
[METERING MODE]..... 87
- AF Mode [AF MODE]..... 88
- Continuous AF [CONT.AF] 90
- AF Assist Lamp
[AF ASSIST LAMP] 90
- Digital Zoom [D.ZOOM] 91
- Color Effect [COL.EFFECT] 91
- Picture Adjustment [PICT.ADJ.] 92
- Flip Animation [FLIP ANIM.] 92
- Conversion Lens
[CONVERSION] 95
- Extra Flash [EXT.FLASH]..... 97
- Extra Flash Burst Mode
[EX.FLASH BURST]..... 99

Playback (advanced)

- Playing Back Pictures with
Audio/Motion Pictures 100
- Using the [PLAY] mode menu 101
 - Playing Back with Slide Show
[SLIDE SHOW]..... 102
 - Setting Favorites [FAVORITE]..... 103
 - Displaying pictures in a direction
at the time of recording
[ROTATE DISP.] 104
 - Rotating the Picture [ROTATE] 105
 - Setting the Picture to be Printed
and the Number of Prints
[DPOF PRINT]..... 106
 - Preventing Accidental Erasure of the
Picture [PROTECT] 108
 - Adding Audio to Recorded Pictures
[AUDIO DUB.] 109
 - Resizing the Pictures [RESIZE]..... 110
 - Trimming the Pictures
[TRIMMING] 111
 - Aspect ratio conversion
[ASPECT CONV.]..... 113
 - Clean-up [CLEAN UP] 114
 - Initializing the Card [FORMAT]..... 115
- Playing Back Pictures
on a TV Screen 116

Connecting to a PC or Printer







- Before Connecting to the PC or
the Printer [USB MODE] 117
- Connecting to a PC..... 118
- Connecting to a PictBridge-compliant
Printer..... 121
- Using the Remote Shutter 125

Others

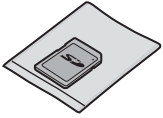
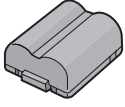
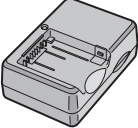
- Using the MC Protector/ND Filter 126
- Screen Display..... 127
- Cautions for Use 129
- Message Display 131
- Troubleshooting..... 133
- Specifications..... 137
- Digital Camera Accessory System 139
- Digital Camera Accessory
Order Form (For USA Customers) 140
- Request for Service Notice
(For USA Only)..... 141
- Limited Warranty (For USA Only) 142
- Customer Services Directory
(For USA Only)..... 144
- Index 145
- Spanish Quick Use Guide/
Guía rápida en español..... 147

Standard Accessories

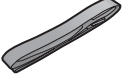
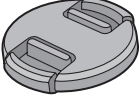
Before using your camera, check the contents.

<p>1</p>  <p>RP-SD032B</p>	
<p>2</p>  <p>CGR-S006A</p>	<p>3</p>  <p>DE-993B</p>
<p>4</p>  <p>K1HA08CD0007</p>	
<p>5</p>  <p>K1HA08CD0008</p>	
<p>6</p> 	<p>7</p>  <p>VFC4124</p>
<p>8</p>  <p>VYK1P30</p>	<p>9</p>  <p>VYQ3505</p>

- 1 SD Memory Card (32 MB)
(In the text, it is called the "Card")
 - 2 Battery Pack
(In the text, it is called the "Battery")
 - 3 Battery Charger
(In the text, it is indicated as "Charger")
(This can be used with multiple product.)
 - 4 USB Connection Cable
 - 5 AV Cable
 - 6 CD-ROM
 - 7 Strap
 - 8 Lens Cap
 - 9 Lens Hood
- For information about optional accessories, please refer to "Digital Camera Accessory System". (P139)

Names of the Components

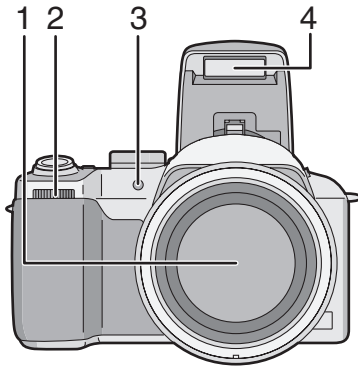

- 1 Lens (P5)
- 2 Front dial (P44, 60, 61, 64, 66)



- 3 Self-timer Indicator (P53)
AF Assist Lamp (P90)
- 4 Flash (P49)

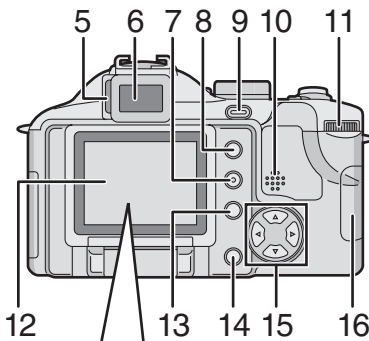

- 5 Diopter Adjustment Dial (P29)
- 6 Viewfinder (P25, 127)
- 7 [DISPLAY] Button (P25)
- 8 [EVF/LCD] Button (P25)
- 9 [AE LOCK] Button (P40)
- 10 Speaker (P100)
- 11 Rear dial (P39, 59, 65, 66)



- 12 LCD Monitor (P25, 26, 127)
- 13 [MENU] Button (P21)
- 14 Delete Button (P62)
- 15 Cursor Buttons
 - ◀/Self-timer Button (P53)
 - ▼/[REV] Button (P44)
 - ▶/Flash Setting Button (P49)
 - ▲/Exposure Compensation (P54)/Auto Bracket (P55)/White Balance Fine Adjustment (P83)/Flash Output Adjustment (P51)/Backlight Compensation in auto mode (P43) Button
- 16 Card Door (P15)
- 17 LCD Monitor open knobs (P26)

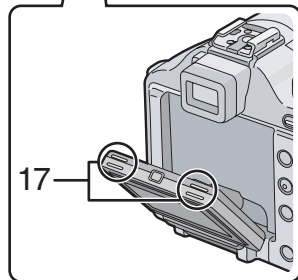

Preparation

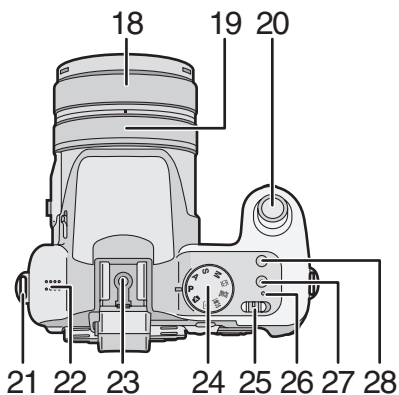

- 18 Zoom ring (P33)
- 19 Focus ring (P46)
- 20 Shutter Button (P37)
- 21 Strap Eyelet (P17)
- 22 Microphone (P69, 87)
- 23 Hot Shoe (P97)
- 24 Mode Dial (P36)
- 25 Camera ON/OFF Switch (P21)
- 26 Power Indicator (P37)
- 27 Single or Burst Mode Button (P57)
- 28 Optical Image Stabilizer Button (P56)

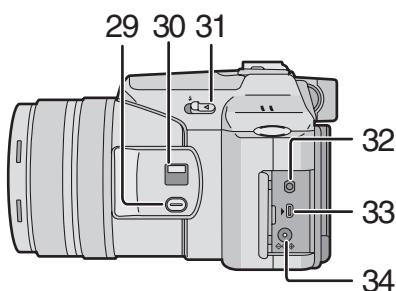

- 29 [FOCUS] Button (P47,77, 89)
- 30 Focus Switch (P42, 45, 46)
(AF/AF MACRO/MF)
- 31 Flash Open Lever (P49)
- 32 [REMOTE] Socket (P125)
- 33 [AV OUT/DIGITAL] Socket
(P116, 118, 121)
- 34 [DC IN] Socket (P118, 121)
 - Please be sure to use genuine Panasonic AC adaptor (DMW-CAC1; optional).

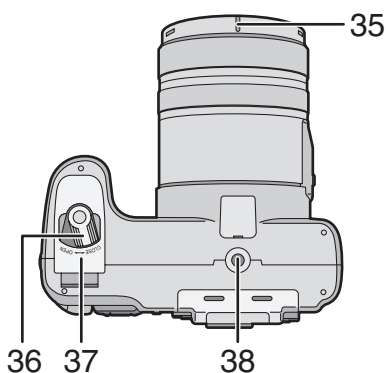

- 35 Lens hood positioning groove (P18)
- 36 Battery Door Open/Close Lever (P14)
- 37 Battery Door (P14)
- 38 Tripod Receptacle
 - When you use a tripod, make sure the tripod is stable with the camera attached to it.

Charging the Battery with the Charger

When the camera is shipped, the battery is not charged. Charge the battery before use.

1 Attach the battery to the charger.

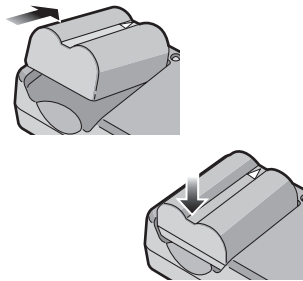

2 Connect the charger to the electrical outlet.

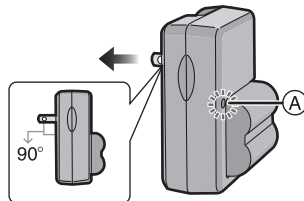

- When the [CHARGE] indicator (A) lights in green, charging starts.
- When the [CHARGE] indicator (A) turns off (in about 120 minutes), charging is completed.

3 Detach the battery after charging is completed.

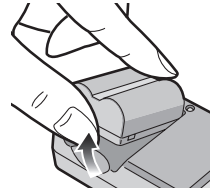

- After charging is completed, be sure to disconnect the charger from the electrical outlet.
- The battery becomes warm after use/charge or during charge. The camera also becomes warm during use. However, it is not a malfunction.
- The battery is exhausted when it is left for a long period of time after being charged. Recharge the battery when it is exhausted.
- **Use the dedicated charger and battery.**
- **Charge the battery with the charger indoors.**
- **Do not disassemble or modify the charger.**

About the Battery (Charging/number of recordable pictures)

■ Battery indication

The remaining battery power appears on the screen.



- The battery indication turns red and blinks.
- Recharge the battery or replace it with fully charged battery.

[It does not appear when you use the camera along with the AC adaptor (DMW-CAC1; optional).]

■ The battery life

The number of recordable pictures by CIPA standard (In program AE mode)

- CIPA is an abbreviation of [Camera & Imaging Products Association].

Number of recordable pictures	Approx. 280 pictures (Approx. 140 min)
-------------------------------	---

Recording conditions by CIPA standard

- Temperature: 23 °C (73.4 °F)/ Humidity: 50% when LCD monitor is on.
- Using the supplied SD Memory Card (32 MB).
- Using the supplied battery.
- Recording starts 30 seconds after the camera is turned on.
- **Recording once every 30 seconds**, with full flash every other recording.
- Turn the camera off every 10 recordings.

The number of recordable pictures varies depending on the recording interval time. If the recording interval time becomes longer, the number of recordable pictures decreases.
(When taking a picture every 2 minutes: Approx. 75)

The number of recordable pictures when using the Viewfinder

(Recording conditions comply with CIPA standard.)

Number of recordable pictures	Approx. 300 pictures (Approx. 150 min)
-------------------------------	---

Playback time when using the LCD monitor

Playback time	Approx. 300 min
---------------	-----------------

The number of recordable pictures and playback time will vary depending on the operating conditions and storing condition of the battery.

■ Charging

Charging time	Approx. 120 min
---------------	-----------------

Charging time and the number of recordable pictures with the optional battery pack (CGR-S006A) are the same as above.

- When charging starts, the [CHARGE] indicator lights.

■ Charging error

- If a charging error occurs, the [CHARGE] indicator blinks in about 1 second cycles. In this case, disconnect the charger from the electrical outlet, remove the battery and make sure that both room and battery temperature are not too low or high and then charge it again. If the [CHARGE] indicator still blinks even if you charge the battery for a while, consult the dealer or your nearest servicenter.
- When the operating time of the camera becomes extremely short even if the battery is properly charged, the life of the battery may have expired. Buy a new battery.

■ Charging conditions

- Charge the battery under temperature of 10 °C to 35 °C (50 °F to 95 °F). (Battery temperature should be the same also.)
- The performance of the battery may be temporarily deteriorated and the operating time may become shorter in low temperature conditions (e.g. skiing/ snowboarding).

Inserting/Removing the Battery

- Check that the camera is turned off.
- Close the flash.

1 Slide the release lever in the direction of the arrow to open the battery door (A).

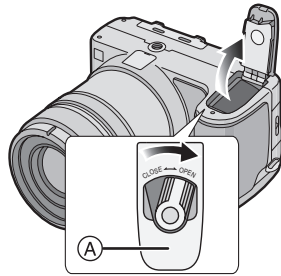

- Please be sure to use genuine Panasonic batteries (CGR-S006A).

2 Insert:
Insert the charged battery until it clicks.

Remove:
Slide the lock (B) to remove the battery.

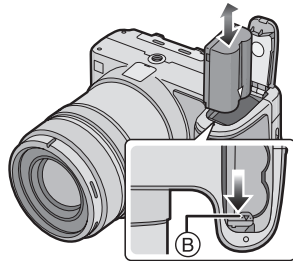

3 **1** Close the battery door.
2 Slide the release lever as far as it will go in the direction of the arrow to close the battery door firmly.

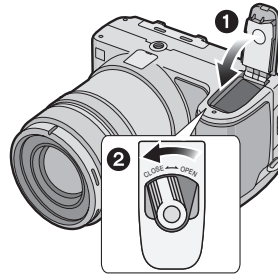

- If you will not be using the camera for a long time, remove the battery.
- When a fully charged battery has been inserted for more than 24 hours, the clock setting is stored (in the camera) for at least 3 months even if the battery is removed. (The storing time may be shorter if the battery is not charged sufficiently.)
If more than 3 months has passed, the clock setting will be lost. In this case, set the clock again. (P20)
- **Do not remove the card and the battery while the card is being accessed. The data on the card may be damaged. (P16)**
- **Do not remove the battery with the camera turned on since the settings on the camera may not be stored properly.**
- **The supplied battery is designed only for the camera. Do not use it with any other equipment.**

Inserting/Removing the Card

- Check that the camera is turned off.
- Close the flash.

1 Slide the card door to open it.

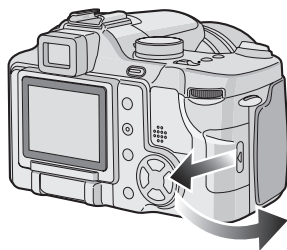

- The card and the data may be damaged if it is inserted or removed while the camera is on.
- We recommend using Panasonic's SD Memory Card. (Use only the genuine SD card with SD Logo.)

2 Insert:

Insert the card fully until it clicks and it is locked with the label facing the front of the camera.

Remove:

Push the card until it clicks, then pull the card out upright.

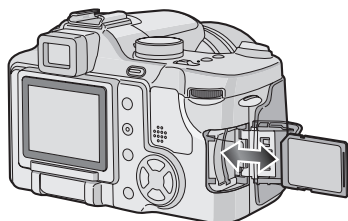

- Check the direction of the card.
- Do not touch the connection terminals on the back side of the card.

- The card may be damaged if it is not fully inserted.

3 ① Close the card door.

- ② Slide the card door to the end to close it firmly.

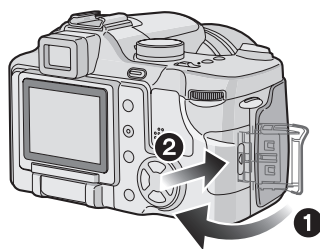

- If the card door cannot be completely closed, remove the card and insert it again.

About the Card

■ Access to the card

When pictures are being recorded onto the card, the card access indication (A) lights red.

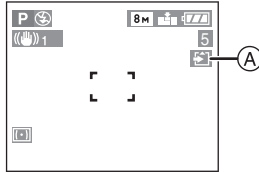

When the card access indication lights, pictures are being read or deleted or the card is cleaned up (P114) or formatted (P115). do not:

- turn the camera off.
- remove the battery or the card.
- shake or impact the camera.

The card and the data may be damaged and the camera may not operate normally.

■ About handling a card

Transfer important pictures/motion pictures from your card to your PC periodically (P118). The data on the card may be damaged or lost due to electromagnetic wave, static electricity, breakdown of the camera or a defective card.

- Do not format the card on your PC or other equipment, format it with the camera only to ensure proper operation. (P115)

■ SD Memory Card (supplied) and MultiMediaCard (optional)

- The SD Memory Card and MultiMediaCard are small, lightweight, removable external cards. The reading/writing speed of an SD Memory Card is fast. The SD Memory Card is equipped with a Write-Protect switch (B) that can inhibit writing and formatting a card. (When the switch is slid to the [LOCK] side, it is not possible to write or delete data on the card and format it. When the

switch is unlocked, these functions become available.)

SD Memory Card

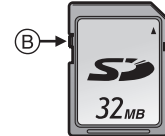

- On this unit, you can use SD Memory Cards of the following capacity (from 8 MB to 2 GB).

**8 MB, 16 MB, 32 MB, 64 MB, 128 MB,
256 MB, 512 MB, 1 GB,
2 GB (Maximum)**

Please confirm the latest information on the following website.

<http://panasonic.co.jp/pavc/global/cs>

(This Site is English only.)

- This unit supports SD Memory Cards formatted in FAT12 system and FAT16 system based on SD Memory Card Specifications.
- This unit does not support MultiMediaCard for recording motion pictures.



- The reading/writing speed of a MultiMediaCard is slower than an SD Memory Card. When a MultiMediaCard is used, the performance of certain features may be slightly slower than advertised.
- After recording motion pictures using the MultiMediaCard, the card access indication may appear for a while, but this is not a malfunction.
- Keep the Memory Card out of reach of children to prevent swallowing.

Removing the Lens Cap/Attaching the Strap

■ Remove the lens cap

1 Pinch the lens cap and remove it.

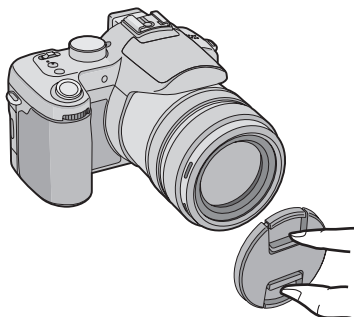

- When you turn the camera off, carry the camera or play back the pictures, attach the lens cap to protect the surface of the lens.
- Detach the lens cap before taking pictures.
- Be careful not to lose the lens cap.

■ Attaching the strap (supplied)

1 Pass the strap through the hole at the Strap Eyelet.

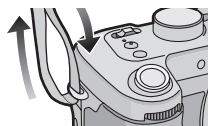

2 Pass the strap through the stopper and fasten the strap.

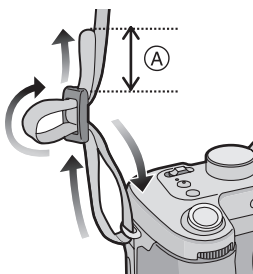

Ⓐ: Pull the strap 2 cm or more.



- Attach the strap to the other side of the camera being careful not to twist it.
- Check that the strap is firmly attached to the camera.
- Attach the strap so that you can see “LUMIX” logo.

Attaching/Removing the Lens Hood

In bright sunlight or backlight, the lens hood will minimize lens flare and ghosting.

The lens hood cuts out excess light and improves the picture quality.

- Check that the camera is turned off.
- Close the flash.

■ When attaching the lens hood

- 1 **Place the camera upside down.**
- 2 **Align lens hood mark (A) with lens hood positioning groove (B) on the unit and insert it straight in**

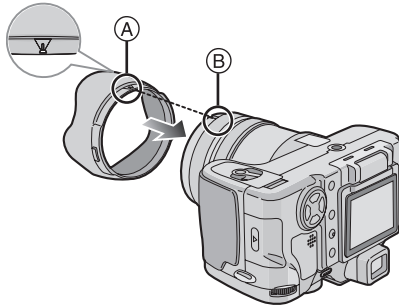

- Make sure the lens hood is properly attached.

■ When removing the lens hood Press lock release button (C) and remove the lens hood

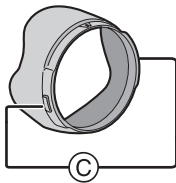

■ Temporarily storing the lens hood (Temporary storage)

- 1 **Place the camera upside down.**
- 2 **Remove the lens hood and turn it around, aligning lens hood mark (A) with lens hood positioning groove (B) on the unit, and insert it straight in**

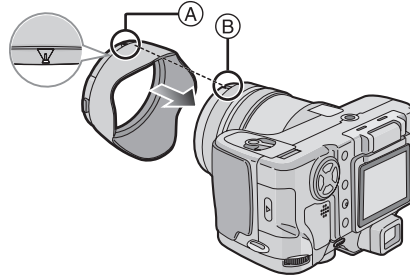

■ When removing the lens hood Press lock release button (C) and remove the lens hood

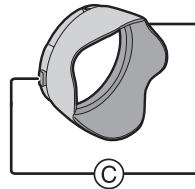

2 Attach the lens cap.

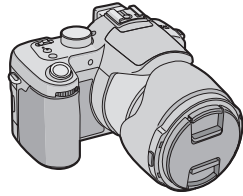

- Ensure that the lens cap is firmly attached.
- When temporarily storing the lens hood, ensure that it is firmly attached and that it is not reflected in the picture.
- When temporarily storing the lens hood, you can detach the lens cap and take pictures. However you cannot use the zoom ring, focus ring, [FOCUS] button or focus switch.



- If you use a flash when the lens hood is attached, the light from the flash is blocked by the lens hood. The bottom of the screen becomes dark (vignetting) and you cannot adjust the flash setting. We recommend removing the lens hood before taking pictures with a flash.
- When using the AF assist lamp in the dark, detach the lens hood.
- For details on how to attach the MC protector and the ND filter, refer to P126.
- When the lens hood is attached, you cannot attach conversion lenses.
- If any of the accessories are lost, please contact Panasonic's parts department at 1 800 833-9626 (For USA) or in Canada call 1 800 561-5505 for more details on how to obtain replacement parts.

Setting Date/Time (Clock Set)

■ Initial setting

The clock is not set when the camera is shipped. When you turn the camera on, the following screen appears.

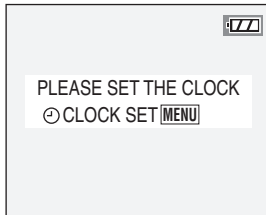

- When pressing the [MENU] button, the screen shown in step 1 appears.
- The screen disappears after about 5 seconds. Turn the camera on again or press the [MENU] button, select [CLOCK SET] in page 2/4 of the [SETUP] menu (P23) and set the clock in steps 1 and 2.

1 Set date and time.

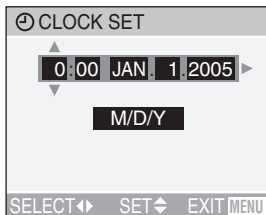

- ◀/▶: Select the desired item.
- ▲/▼: Set date and time.

2 Select [M/D/Y], [D/M/Y] or [Y/M/D].

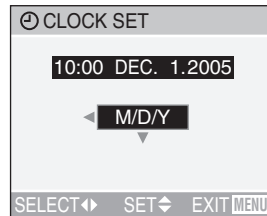

- Close the menu by pressing the [MENU] button 2 times after finishing the setting.
- Check if the clock setting is correct, after turning the camera off and on.



- When a fully charged battery has been inserted for more than 24 hours, the clock setting is stored (in the camera) for at least 3 months even if the battery is removed. (The storing time may be shorter if the battery is not charged sufficiently.)
If more than 3 months has passed, the clock setting will be lost. In this case, set the clock again.
- You can set the year from 2000 to 2099. The 24-hour system is used.
- When you use a photo printing service, if the date is not set in the camera, it will not be printed, even if the store provides a date printing option to your photo.
- For the date print setting, refer to P107.

About the Setup Menu

- Set the items if necessary. (Refer to P22–24 for each menu item.)

1 Turn the camera on.

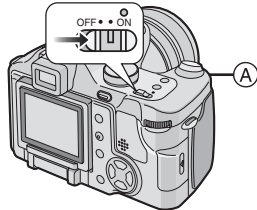

- The menu items depend on the mode selected with the mode dial (P36). In this page, the setup menu [MONITOR] settings in program AE mode [P] are shown as an example.

2 Press the [MENU] button.

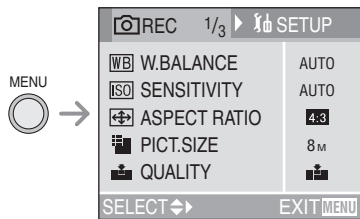

3 Select the [SETUP] Menu.

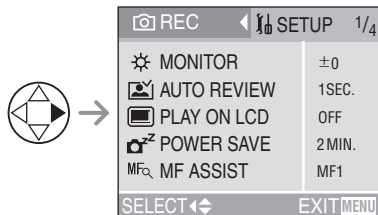

- Rotate the front dial (A) to switch between pages 1/4, 2/4, 3/4 and 4/4.

4 Select the desired item.

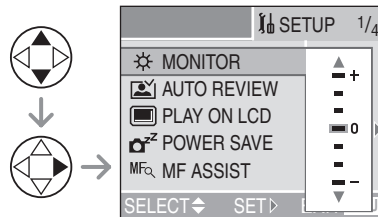

5 Select the desired value.

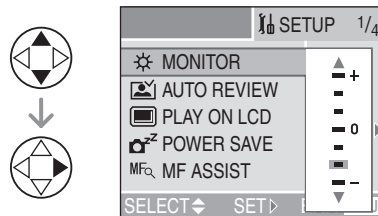

Be sure to press ► at the end to store the setting.

- Close the menu by pressing the [MENU] button after finishing the setting. In recording mode, you can also close the menu by pressing the shutter button halfway.

[SETUP] menu (Refer to P21 for the setting method.) **[MONITOR/VIEWFINDER]**

Adjust the brightness of the LCD monitor (when pictures appear on the LCD monitor) or Viewfinder (when pictures appear on the Viewfinder) in 7 steps.

 **[AUTO REVIEW]**





[OFF]: The recorded picture does not automatically appear.

[1SEC.]: The recorded picture automatically appears on the screen for about 1 second.

[3SEC.]: The recorded picture automatically appears on the screen for about 3 seconds.

[ZOOM]: The recorded picture automatically appears on the screen for about 1 second. Then it is enlarged 4 times and appears for about 1 second. This mode is useful for confirming focus.

Pictures in auto bracket, burst mode or pictures with audio are not enlarged even if [ZOOM] is selected.

- In motion picture mode () , auto review function is not activated.
- When pictures are recorded in auto bracket () (P55) or any speed () , () and () on burst mode (P57), the auto review function is activated regardless of the setting on the auto review function. (The picture is not enlarged.)

- When using pictures with audio, the auto review function works while recording the audio or the data into the card regardless of the setting on the auto review function. (The picture is not enlarged.)

- When the quality is set to [TIFF] or [RAW], the auto review function works until the end of recording onto the card. (The picture is not enlarged.)

- The setting for the auto review function is disabled in auto bracket, burst mode, motion picture mode, or when [AUDIO REC.] is set to [ON].

 **[PLAY ON LCD]**

When Viewfinder is selected in the recording mode while setting [PLAY ON LCD] to [ON], the picture automatically appears on the LCD monitor in review or playback. (P29)

[SETUP] menu (Refer to P21 for the setting method.) **[POWER SAVE]****[1MIN.]/[2MIN.]/[5MIN.]/[10MIN.]:**

The power save mode is activated (the camera is automatically turned off to save the battery life) if the camera has not been used for the time selected on the setting.

[OFF]: The power save mode is not activated.

- Press the shutter button halfway or turn the camera off and on to cancel the power save mode.
- When using the AC adaptor (DMW-CAC1; optional)/connecting to a PC or a printer/recording motion pictures/playing back motion pictures/during Slide Show, the power save mode is not activated. (However, during a manual Slide Show, the setting for the power save mode is fixed to [10MIN.]

 **[MF ASSIST]****(Recording mode only)**

In manual focus, assistance screen appears on the center of the screen to facilitate focusing on the subject. (P46)

[MF1]: The center of the screen is enlarged. You can adjust the focus while determining the composition of the whole of the screen.

[MF2]: The whole of the screen is enlarged. It is convenient for adjusting the focus in Wide.

[OFF]: The screen is not enlarged.

 **[BEEP]**

: No operational sound

: Soft operational sound

: Loud operational sound

 **[SHUTTER]**

Set to select the volume of shutter sound.

: No shutter sound

: Soft shutter sound

: Loud shutter sound

 **[VOLUME]**

The volume of speakers can be adjusted in 7 steps. (LEVEL 6 to 0)

- When you connect the camera to a TV, the volume of the speakers of the TV is not changed.

 **[CLOCK SET]**

Change date and time. (P20)

 **[NO.RESET]**

Set this when you want to start the file number of the picture from 0001 on the next recording. (The folder number is updated, and the file number starts from 0001.)

- The folder number can be assigned from 100 to 999.

When the folder number reaches 999, you cannot reset the file number. We recommend formatting the card after saving the data on a PC or elsewhere.

- To reset the folder number to 100, format the card first and then use this function to reset the file number.

After that, the reset screen for the folder number appears. Select [YES] to reset the folder number.

- Refer to P119 for detailed information about the file number and the folder number.

[SETUP] menu (Refer to P21 for the setting method.)** [RESET]**

The settings on the [REC] or the [SETUP] menu are reset to the initial settings.

- The birthday setting for [BABY] (P75) in the scene mode is also reset when the settings in the [SETUP] menu are reset.
- [ROTATE DISP.] (P104) in the [PLAY] mode menu is also reset to [ON].
- The folder number and the clock setting are not changed.

 [USB MODE]

Set the USB communication system.

- Set before connecting to a PC or a printer. (P117)

 [HIGHLIGHT]

When the auto review or review function is activated, a white saturated area appears blinking in black and white. (P29)

 [VIDEO OUT]

(Playback mode only) (P116)

- [NTSC]: Video output is set to NTSC system.
- [PAL]: Video output is set to PAL system.

 [SCENE MENU]

[OFF]: [SCENE MODE] menu does not appear when setting the mode dial to [SCN1] or [SCN2] and the camera is operated in the scene mode currently selected. If you change the scene mode, Press the [MENU] button to display the [SCENE MODE] menu and then select the desired scene mode.

[AUTO]: [SCENE MODE] menu appears automatically when setting the mode dial to [SCN1] or [SCN2]. Select the desired scene mode.

 [LANGUAGE]

Set to the language on the menu screen from the following languages. Set to the desired language with ▲/▼ and store it with ►.

- [ENGLISH]: English
- [DEUTSCH]: German
- [FRANÇAIS]: French
- [ESPAÑOL]: Spanish
- [ITALIANO]: Italian
- [中文]: Chinese (Traditional)
- [日本語]: Japanese

- When you set to other language by mistake, select [] from the menu icons to set the desired language.

About the LCD Monitor/Viewfinder

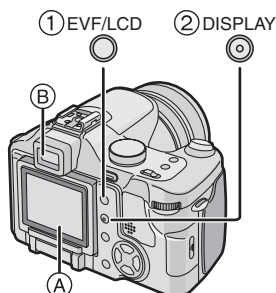

① Switching the LCD monitor/Viewfinder

Press the [EVF/LCD] button to switch the monitor screen. (When the LCD monitor is closed with the screen facing outwards)

Ⓐ LCD monitor (LCD)

Ⓑ Viewfinder (EVF)

- When the LCD monitor turns on, the Viewfinder turns off (and vice versa).

② Selecting the screen to be used

Press the [DISPLAY] button to change the display.

- When the menu screen appears, the [DISPLAY] button is not activated. During multi playback (P60) or playback zoom (P61) and when playing back with Slide Show (P102), the indications on the screen can be turned on and off.

In recording mode (P37)

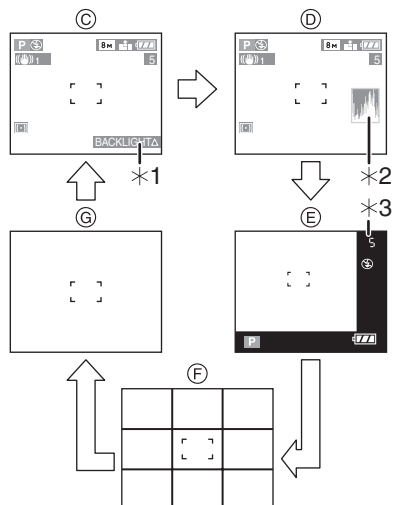

Ⓒ Normal display

Ⓓ Display with histogram

Ⓔ Out-of-frame display

Ⓕ No display (Recording guide line)

Ⓖ No display

*1 Backlight Compensation

(Appears only in auto mode)

*2 Histogram

*3 When the number of pictures remaining is more than 1000 or the time remaining in motion picture mode is more than 1000 seconds, [+999] is displayed.

Preparation

In playback mode (P59)

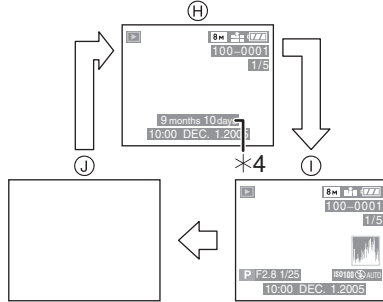

- Ⓜ Normal display
- Ⓛ Display with recorded information and histogram
- Ⓜ No display
- *4 Displayed when you set birthday setting for [BABY] (P75) in the scene mode, and [WITH AGE] is selected at taking pictures.

■ LCD Monitor

Adjusting the LCD monitor makes it possible to take pictures from various angles.

■ Taking pictures at a normal angle.

- You can switch between the LCD monitor and the Viewfinder.

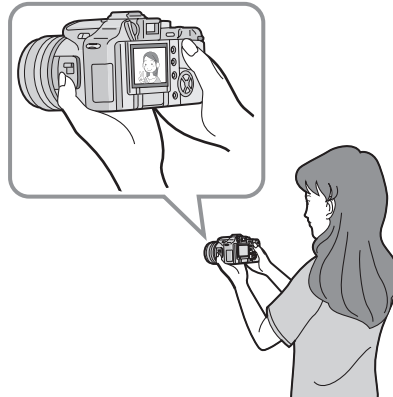

■ Taking pictures at a high angle

Open the LCD monitor with one of the LCD monitor open knobs.

- You can use the LCD monitor only.

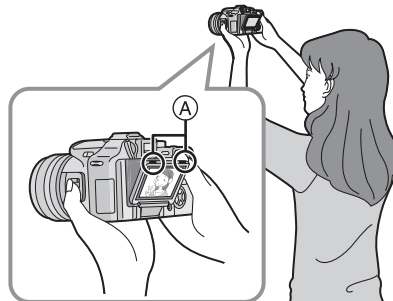

Ⓐ:LCD Monitor open knobs

- This is convenient when there is someone in front of you and you cannot get close to the subject.

■ **Taking pictures at a low angle**
Open the LCD monitor with one of the LCD monitor open knobs, pull the LCD monitor fully open (approximately 120°) and rotate it 180°.

- You can use the LCD monitor only.

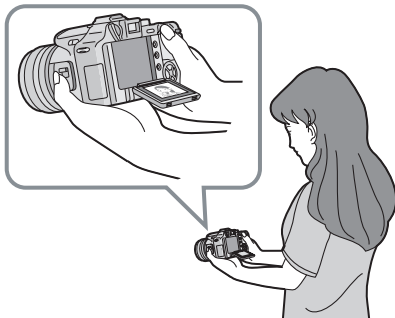

LCD monitor rotation direction

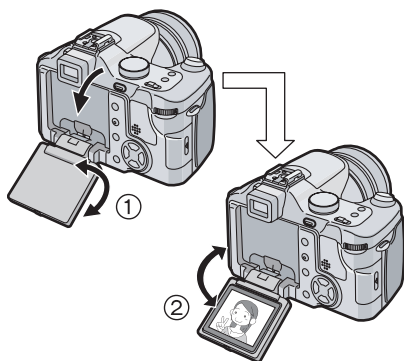

- ①: Maximum 180°
- ②: Maximum 120°

- This is convenient when taking pictures of flowers etc. that are in a low position.



- If the LCD monitor turns on when it is closed with the screen facing inwards, the camera automatically switches to the Viewfinder.
- If the LCD monitor is opened when the Viewfinder is turned on, the camera automatically switches to the LCD monitor.
- **Only rotate the LCD monitor after opening it wide enough, and be careful not to use excessive force as it may be damaged.**
- When holding the edge of the LCD monitor, there may be some distortion, however this is not a malfunction. Moreover, this has no effect on the taken pictures or playback.
- When not using the LCD monitor it is recommended that you close it with the screen facing inwards to prevent dirt and scratches.

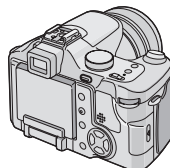

- When using a tripod, depending on the kind of tripod the LCD monitor may not rotate.

■ **About the Viewfinder**

The Viewfinder is convenient when you want to take pictures of a moving subject or outdoors.

- Refer to page 29 for information about diopter adjustment.



- When using the Viewfinder, close the LCD monitor.
- When the LCD monitor is open, the Viewfinder cannot be used.

■ Tips for taking good pictures

To take pictures without blurring:

- Hold the camera gently with both hands, keep arms stationary at your side and stand with your feet slightly apart.
- Make sure that camera shake does not occur when you press the shutter button.
- Do not cover the microphone or the AF assist lamp with your finger or other objects.
- Do not touch the front of the lens.

When recording with LCD Monitor

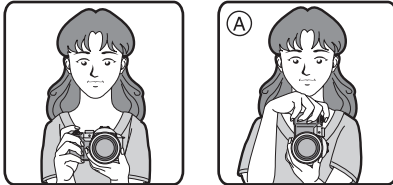

When recording with Viewfinder



Ⓐ: When holding the camera vertically

- If you take pictures by holding the camera vertically, use the LCD monitor at the normal angle.
- Refer to page P39 for information about jitter (camera shake).

■ Direction detection function

- If you take pictures by holding the camera vertically, the information of the rotation on the pictures is automatically added and recorded to the pictures.

When [ROTATE DISP.] (P104) is set to [ON], you can rotate and display pictures on the screen or the TV according to the information of the rotation on the pictures.

- This function may not work properly on pictures recorded by aiming the camera up or down.
- You cannot use the direction detection function in motion picture mode [] and when you create flip animation.

■ Out-of-frame display

The recording information is displayed out of the recording screen, therefore, you can take pictures without obstruction from icons or others on the monitor, except the zoom and important warning indicators.

■ Diopter adjustment

This feature is handy for users who wear corrective lenses and prefer to use the Viewfinder.

- Close the LCD monitor and press the [EVF/LCD] button to display the viewfinder.

Adjust the diopter, rotating the diopter adjustment dial.

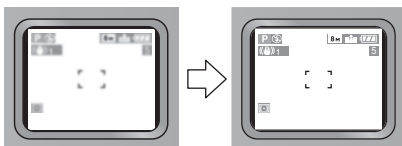
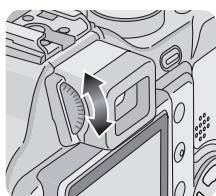

■ Monitor priority

When setting [PLAY ON LCD] to [ON] on the [SETUP] menu (P22), the LCD monitor is turned on in the following cases.

You can save the time it takes to switch the display to the LCD monitor even when using the Viewfinder in recording.

- When the recording mode is switched to playback mode.
- When reviewing pictures. (P44)
- When turning the camera on in playback mode.

■ Recording guide line

When you align the subject on the horizontal and vertical guide lines or the cross point of these lines, you can take pictures with well-designed composition by viewing the size, the slope and the balance of the subject.



■ Highlight display

When setting [HIGHLIGHT] to [ON] on the [SETUP] menu (P24) while the auto review or review function is activated, any white saturated area (extremely bright or glistening part) on the picture appears blinking in black and white.

- If you compensate the exposure to minus, referring to the histogram and then take a picture again, it may result in a good picture.

No highlight display

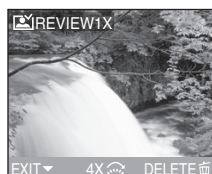

With highlight display



■ Histogram

- A histogram is a graph that displays brightness along the horizontal axis (black to white) and the number of pixels at each brightness level on the vertical axis.
- It allows the camera user to easily check the way a picture is being exposed.
- It is very useful if manual adjustments of the lens aperture and shutter speed are available, especially in those situations where automatic exposure may be difficult due to uneven lighting. Using the histogram feature will allow you to get the best performance from the camera.
 - When the values are concentrated to the left, the picture is under exposed.
 - When the values in the histogram are distributed evenly, the exposure is adequate and the brightness is well-balanced.
 - When the values are concentrated to the right, the picture is over exposed.

Example of histogram

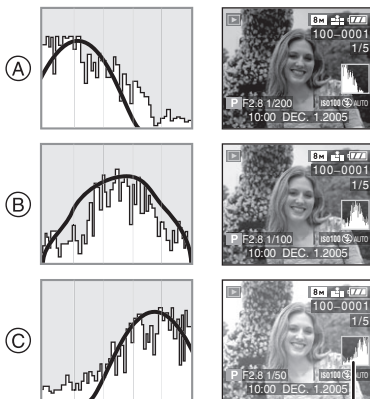







*





- Under Exposed
 - Properly Exposed
 - Over Exposed
- *Histogram



- **When the recorded picture and the histogram do not match each other under the following conditions, the histogram is displayed in orange.**
 - When the flash is activated
 - When the flash is closed
 - When the brightness of the screen is not correctly displayed in dark places
 - When the exposure is not adequately adjusted
- The histogram does not appear when in motion picture mode [M], during multi playback and playback zoom.
- The histogram in the recording mode is an approximation.
- The histogram in recording and playback may not match each other.
- The histogram in the camera does not match the one displayed in image editing software used with a PC, etc.
- Check white saturated areas with the highlight display in the auto review function or the review function. (P29)

Approximate number of recordable pictures and the size

Aspect Ratio	4:3									
Picture size	8M (8M): (3264×2448 pixels)				5M (5M EZ): (2560×1920 pixels)			3M (3M EZ): (2048×1536 pixels)		
	TIFF			RAW	TIFF			TIFF		
16 MB	0	3	7	0	0	5	11	1	9	17
32 MB	1	7	15	1	1	12	24	3	19	37
64 MB	2	15	31	3	3	25	49	6	39	75
128 MB	4	31	62	7	8	51	100	12	79	150
256 MB	9	61	120	13	15	99	195	24	150	290
512 MB	19	120	240	27	30	195	380	48	300	590
1 GB	38	240	480	54	61	390	770	96	610	1180
2 GB	77	490	970	105	125	790	1530	195	1220	2360

Aspect Ratio	4:3					
Picture size	2M (2M EZ): (1600×1200 pixels)			1M (1M EZ): (1280×960 pixels)		
	TIFF			TIFF		
16 MB	2	14	28	3	22	41
32 MB	4	30	59	7	46	86
64 MB	10	62	120	15	94	175
128 MB	20	125	240	31	190	350
256 MB	39	240	470	61	370	690
512 MB	78	480	940	120	730	1370
1 GB	155	970	1880	240	1470	2740
2 GB	310	1920	3610	490	2920	5120

Preparation

Aspect Ratio	3:2									
Picture size	7M (7M): (3248×2160 pixels)				4.5M (4.5M EZ): (2560×1712 pixels)			2.5M (2.5M EZ): (2048×1360 pixels)		
	TIFF			RAW	TIFF			TIFF		
16 MB	0	4	8	0	1	6	12	1	10	19
32 MB	1	8	17	1	2	13	27	3	21	41
64 MB	2	17	35	3	4	28	55	6	44	84
128 MB	5	36	71	7	8	57	110	14	89	170
256 MB	10	70	135	15	17	110	210	27	170	330
512 MB	21	135	270	30	34	220	430	54	340	650
1 GB	43	270	540	60	69	440	860	105	680	1310
2 GB	87	560	1090	120	140	890	1700	210	1360	2560

Aspect Ratio	16:9							
Picture size	5.5M (5.5M): (3072×1728 pixels)				2M (2M EZ): (1920×1080 pixels)			
	TIFF			RAW	TIFF			
16 MB	0	5	10	1	2	13	25	
32 MB	1	11	22	2	4	28	54	
64 MB	3	23	46	4	9	58	110	
128 MB	7	47	93	9	18	115	220	
256 MB	14	92	180	18	36	230	430	
512 MB	28	180	350	36	72	450	860	
1 GB	57	360	710	72	145	910	1720	
2 GB	115	740	1420	145	290	1800	3410	



- The aspect ratio is the horizontal to vertical ratio of a picture. Refer to P84 for the aspect ratio.
- If you set the quality to [RAW], the picture size is fixed to the maximum picture size for each aspect ratio.
- If you select a larger picture size, you can print pictures clearly. When you select a smaller picture size, you can record more pictures. (P85)
- EZ is an abbreviation for [Extended Optical Zoom]. Selecting a picture size with EZ displayed, allows you to magnify the subject up to a maximum of 19.1 times when the digital zoom is set to [OFF]. (P34)
- Refer to P86 for information about quality.
- The numbers are approximations. (The numbers vary depending on the recording condition and the type of the card.)
- The number of recordable pictures varies depending on subjects.
- The remaining number of recordable pictures displayed on the screen is an approximation.

About the zoom

Using the Optical Zoom

P A S M SCN1 SCN2 A

You can make people and subjects appear closer with the 12 times optical zoom, and landscapes can be recorded in wide angle.

■ To make subjects appear further away use (Wide)

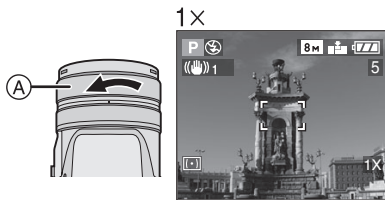

■ To make subjects appear closer use (Tele)

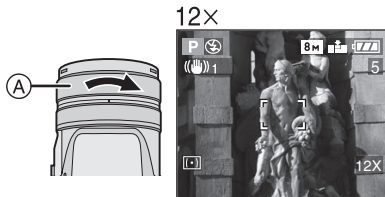

Ⓐ: Zoom ring



- The picture may have some distortion (typical example: vertical straight line bent outwards). This is due to the lens aberration, which is common to some extent with all photographic lenses. Distortion may be more visible when using a wider area of the zoom lens as you get closer to the subject.
- When using the zoom lens at high magnification, the quality of the picture can be enhanced if a tripod is used. At high magnification, even small movements can cause a slight decrease in picture sharpness.
- If you use the zoom function after focusing on the subject, focus on the subject again.
- The indicated zoom magnification is an approximation.
- **When you rotate the zoom ring, you may hear some sound from the camera or the camera may be shaken. This is not a malfunction.**

Using the Digital Zoom



In the [REC] menu (P81), setting [D.ZOOM] to [2×] or [4×] allows you to magnify a subject up to a maximum of 48 times. (Except when using extended optical zoom.)

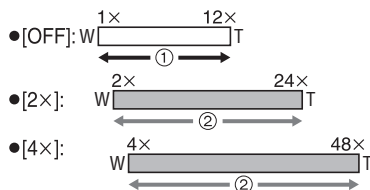

- ① Optical zoom
- ② Digital zoom

■ **The digital zoom and extended optical zoom can be used together.**

Example: When the digital zoom is set to [4×] and the picture size to [3M EZ], you can use the extended optical zoom [3M] at the same time.

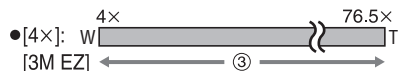

- ③ When using the digital zoom [4×] and the extended optical zoom [3M] [3M EZ] (maximum 19.1 times) together.



- The digital zoom is temporarily set to [OFF] in the following cases.
 - When taking pictures in auto mode [A] (P42)
 - When the quality is set to [RAW] (P86)
 - When [CONVERSION] on the [REC] menu is set to [Off] (P95)
- When using the digital zoom, the picture quality becomes deteriorated.
- When using the digital zoom, the stabilizer function may not be effective.

- When using the digital zoom, we recommend using a tripod and the self-timer (P53) for taking pictures.
- The indicated zoom magnification is an approximation.
- When using the digital zoom, the AF area is displayed with a size wider than usual and set only to a point on the center of the screen. (P89)

Using the Extended Optical Zoom (EZ)



Normally you can make people and subjects appear up to 12 times closer with the optical zoom. However if you set the picture size to [[3M] [3M EZ] etc., the extended optical zoom is activated and the zoom is further enhanced as shown below.

1× 35 mm

Picture size with the extended optical zoom not activated (example: [[8M] (8M))

12× 420 mm

Picture size with the extended optical zoom activated (example: [[3M] (3M EZ))

19.1× 668 mm

Picture size and maximum zoom magnification

(○: Available, —: Not available)

Aspect ratio	Picture size	Maximum zoom magnification	Extended optical zoom
4:3	8M (8M)	12×	—
3:2	7M (7M)		
16:9	5.5M (5.5M)		
4:3	5M (5M EZ)	15.3×	○
3:2	4.5M (4.5M EZ)		
4:3	3M (3M EZ)	19.1×	○
	2M (2M EZ)		
	1M (1M EZ)		
3:2	2.5M (2.5M EZ)		
16:9	2M (2M EZ)		

Extended optical zoom mechanism

- When you set the picture size to [3M] (3M EZ) (3 million pixels), the 8M (8 million pixels) CCD area is cropped to the centre 3M (3 million pixels) area, allowing a picture with a higher zoom effect.



- You can further enhance the zoom magnification with the extended optical zoom without worrying about further picture distortion.
- If you set a picture size that activates the extended optical zoom, the extended optical zoom icon [EZ] is displayed on the LCD monitor when you use the zoom function.
- The zoom movement quickens near Wide (1×) when using the extended optical zoom.
- When you rotate the zoom ring near the Tele position, the on-screen zoom indication may momentarily pause. This is not a malfunction.
- Setting [D.ZOOM] in the [REC] mode menu to [ON] allows you to use the digital zoom for recording an even larger picture. However picture quality will deteriorate. (P34)
- In motion picture mode [H], the extended optical zoom does not work.

The Mode Dial

This camera has a mode dial to suit recording of many kinds of scenes. Select the desired mode and enjoy the variety of recording. Rotate the mode dial slowly and securely.

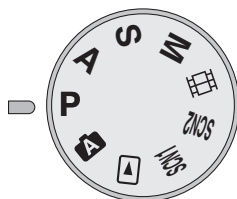

P : Program AE mode (P37)

The exposure is automatically adjusted by the camera.

A : Aperture-priority AE (P64)

The shutter speed is automatically determined by the aperture value you set.

S : Shutter-priority AE (P65)

The aperture value is automatically determined by the shutter speed you set.

M : Manual exposure (P66)

The exposure is adjusted by the aperture value and the shutter speed which are manually adjusted.

[Icon] : Motion picture mode (P69)

This mode allows you to record motion pictures.

SCN1 : Scene mode 1

SCN2 : Scene mode 2 (P71)

This mode allows you to take pictures depending on the recording scenes. This mode also allows you to set [SCENE MENU] (P24) on the [SETUP] menu to [OFF] and set the scene modes which are frequently used to [SCN1] and [SCN2] on the mode dial.

It is convenient because you can select the scene mode quickly and minimize the operation.

[Play button icon] : Playback mode (P59)

This mode allows you to play back recorded pictures.

[Camera icon] : Auto mode (P42)

Even beginners can easily take pictures.

Taking Pictures

■ Program AE



The camera automatically sets the shutter speed and the aperture value according to the brightness of the subject.

- Remove the lens cap.

- 1 Turn the camera on.
- 2 Set the mode dial to program AE mode [P].

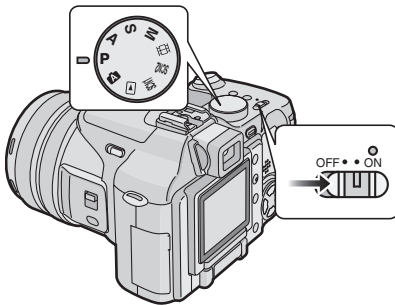

- The power indicator (green) lights. When it blinks, the remaining battery power is low. Insert a fully charged battery.

- 2 Aim the AF area ① to the point you want to focus and then press the shutter button halfway.

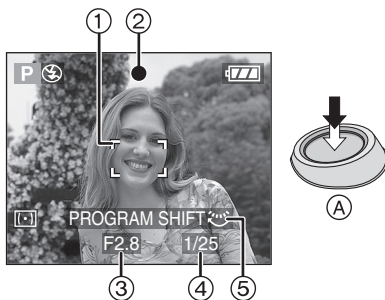

- (A): Press the shutter button halfway to focus.
- The focus indication ② is lit and then the aperture value ③, the shutter speed ④ and program shift ⑤ are displayed.
- When 9-area-focusing or 3-area-focusing (High speed) is used for AF mode, the AF area will not appear until the subject is brought into focus. (P88)
- Refer to P39 for information about Program shift and P89 for information about selecting the AF area.

- 3 Take a picture.

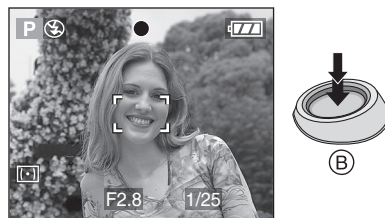

- (B): Press the shutter button fully to take the picture.

	When the subject is not focused	When the subject is focused
Focus indication	Blink (green)	On (green)
AF area	White to red or no AF area	Turns from white to green
Sound	Beeps 4 times	Beeps 2 times

■ **When you want to take a subject out of the AF area (AF/AE Lock)**



When recording a picture of people with a composition as the above picture, you cannot focus on the subject because it is out of AF area in usual operation.

In this case,

1 Aim the AF area at the subject.

2 Press the shutter button halfway to fix the focus and the exposure.

- When the subject is focused, the focus indication lights.

3 Keeping pressing the shutter button halfway, move the camera as you compose the picture.

4 Press the shutter button fully.

- You can repeatedly retry AF/AE lock before pressing the shutter button fully.

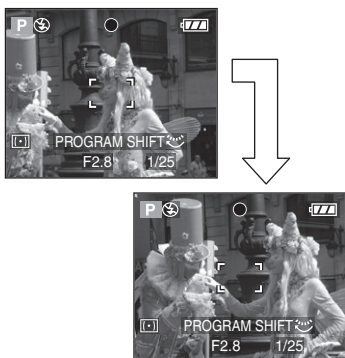

■ **Focusing**

- The focus range is 30 cm (0.98 feet) to ∞ (Wide), 2 m (6.56 feet) to ∞ (Tele).
 - When you press the shutter button fully with one stroke, pictures may be blurry or unfocused.
 - When the focus indication is blinking, the subject is not focused. Press the shutter button halfway and focus on the subject again.
 - If the camera will not focus after a few tries, turn it off and on and try again.
 - In the following cases, the camera will not focus on subjects properly.
 - When including both near and distant subjects in a scene.
 - When there is dirt or dust on the glass between the lens and the subject.
 - When there are illuminated or glittering objects around the subject.
 - When taking a picture in a dark place.
 - When the subject is moving fast.
 - When the scene has low contrast.
 - When jitter occurs.
 - When recording a very bright subject.
- We recommend taking pictures using AF/AE lock or autofocus (P48). In dark places, the AF assist lamp (P90) may turn on to focus on the subject.
- Even if the focus indication appears and the subject is focused, it is canceled when you release the shutter button. Press the shutter button halfway again.
 - Please do not rotate the zoom ring during auto focus.

■ Jitter (camera shake)

- Be careful of jittering when pressing the shutter button, especially when fully zoomed into the subject.
- When jitter could occur because of slow shutter speed, the jitter alert (A) appears.

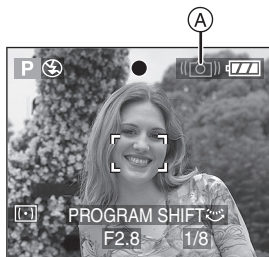

- When the jitter alert appears, we recommend using a tripod. If you cannot use a tripod, be careful of how you hold the camera (P28). The use of the self-timer (P53) prevents jittering at pressing the shutter button when you are using a tripod.
- Especially in the following cases, the shutter speed will be slower. Keep the camera still from the moment you press the shutter button until the picture appears on the screen. We recommend using a tripod.
 - Slow sync./Red-eye reduction [⚡👁️] (P49)
 - [NIGHT PORTRAIT] (P74)
 - [NIGHT SCENERY] (P74)
 - [CANDLE LIGHT] (P76)
 - [PARTY] (P77)
 - [FIREWORKS] (P77)
 - [STARRY SKY] (P79)
 - When you set to a slower shutter speed (P65, 66)

■ Program shift

In Program AE mode, you can change the preset aperture value and the shutter speed under the same exposure. This is called Program shift.

By this function, you can make the background more blurred (by decreasing the aperture value) or record the moving subject more dynamically (by setting to slow shutter speed) in Program AE mode.

- Press the shutter button halfway and then rotate the rear dial to activate the Program shift while the aperture value and the shutter speed are displayed on the screen (for about 10 seconds).

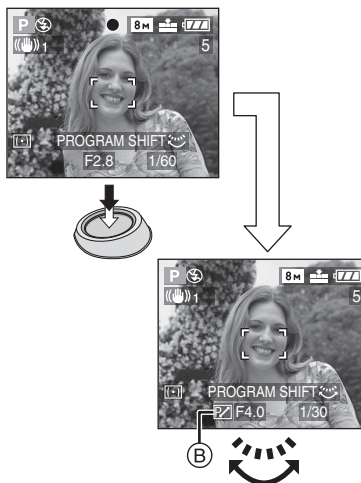

- When the Program shift is activated, the Program shift indication (B) appears on the screen.

■ Example of Program shift

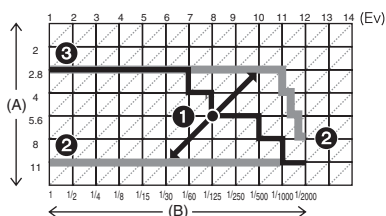

(A): Aperture value

(B): Shutter speed

① Program shift amount

② Program shift line chart

③ Program shift limit



- If the exposure is not adequate when pressing the shutter button halfway, the shutter speed turns red.
- When 10 or more seconds have passed after the Program shift becomes effective, the status to activate the Program shift is canceled and returned to the Program AE mode. However, the setting on the Program shift is memorized.
- Program shift is canceled when turning the camera off.
- The Program shift may not be activated depending on the brightness of the subject.

■ AE Lock Button

This function is convenient if you need to change the picture composition after you have pressed the shutter button halfway and determined the exposure.

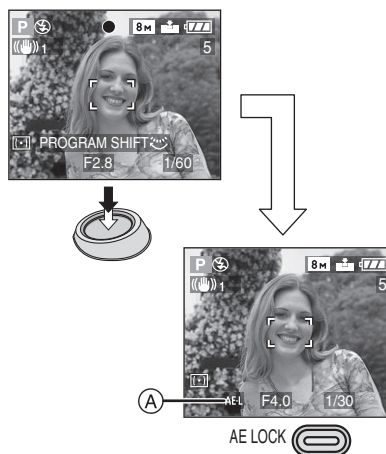

- 1 Aim the camera at the subject you want the exposure to be set for.
- 2 Press the shutter button halfway.
- 3 Press the [AE LOCK] button when the aperture value and shutter speed are displayed.
 - The AE lock icon (A) appears on the screen.

- The exposure is set, even if the brightness of the subject changes.
- Press the [AE LOCK] button when the aperture value and shutter speed are displayed.
- Press the [AE LOCK] button once more to cancel the AE lock.
- Program shift can be set even when AE is locked.
- The [AE LOCK] button cannot be used with manual exposure, motion picture mode [M], scene mode or auto mode.
- The AE Lock function cannot be used if you do not press the shutter button halfway before pressing the [AE LOCK] button.

■ Exposure

- If you press the shutter button halfway when the exposure is not adequate, the indication of the aperture value and the shutter speed turns red. (However, the aperture value and the shutter speed do not turn red when the flash is activated.)
- The brightness of the screen may differ from that of recorded pictures. In particular, when taking pictures in dark places with slow shutter speed, the subject looks dark on the screen, but the actual picture is bright.
- When most of the subjects in the screen are bright (e.g. blue sky on a clear day, snowy field, etc.), the recorded pictures may become dark. In this case, compensate the exposure value on the camera. (P54)



- When you press the shutter button, the LCD monitor may become bright or dark for a moment. This function allows easy adjustment of focus and the recorded picture will not be affected.
- We recommend making sure the clock is set properly before taking pictures. (P20)
- When the time for power save is set (P23), the camera is automatically turned off if you do not operate within the set time. When operating the camera again, press the shutter button halfway or turn the camera off and on.
- In some cases, if the distance between the camera and the subject is beyond the recordable range when you use the camera, the picture may not be properly focused even if the focus indication is lit.



Taking Pictures in Auto Mode



The settings for those functions which are easy to make mistakes with are fixed at the time of purchase allowing pictures to be taken with fewer mistakes.

■ Auto Mode Settings

In auto mode the following items are fixed at the time of purchase to prevent mistakes being made when using the camera.

[W.BALANCE]	[AUTO]	P82
[SENSITIVITY]	[AUTO]	P84
[AUDIO REC.]	[OFF]	P87
[METERING MODE]	[ <td>P87</td>	P87
[AF MODE]	[ <td>P88</td>	P88
[CONT.AF]	[OFF]	P90
[AF ASSIST LAMP]	[ON]	P90
[D.ZOOM]	[OFF]	P91
[PICT.ADJ.]	[STD.]	P92
[FLIP ANIM.]	Cannot be set	P92
[EXT.FLASH]	[PRESET]	P97

- Select [AF] or [AF MACRO] with the focus switch.

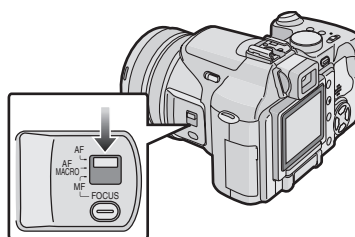

■ The Backlight Compensation

Backlight is a situation where light comes from the back of subjects. The subjects such as people become dark when pictures are recorded in backlight. If you press ▲, [] (compensating backlight ON indication) appears and the backlight compensation function is activated. This function compensates the backlight by brightening the whole of the picture.

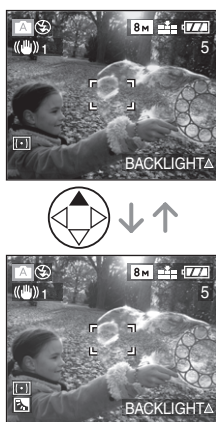

- If you press ▲ while [] is displayed, [] disappears and the backlight compensation function is canceled.
- When you use the backlight compensation function, we recommend using the flash.
- If you use the flash when the backlight compensation function is activated, the flash setting is fixed to Forced ON [].



- Even if the focus switch is set to [AF], you can take pictures approaching the subject at a distance of up to 5 cm (0.16 feet) from the lens by rotating the zoom ring upmost to Wide the same as if [AF MACRO] was selected.
- The settings for [ASPECT RATIO], [PICT.SIZE], [QUALITY] and [CONVERSION] in auto mode are applied to other recording modes.
- You cannot use the following functions in auto mode.
 - White balance fine adjustment
 - Exposure compensation
 - Auto bracket
 - [AUDIO REC.]
 - Flash Output Adjustment
 - [D.ZOOM]
 - [COL.EFFECT]
 - [PICT.ADJ.]
 - AE Lock

Checking the Recorded Picture (Review)



1 Press ▼ [REV].



- The last recorded picture appears for about 10 seconds.
- Press the shutter button halfway or press ▼ [REV] again to cancel the review.
- You can check other pictures by pressing ◀/▶.
- When the recorded pictures are too bright or dim, compensate the exposure. (P54)

2 Enlarge and shift the picture.



- : 1X → 4X → 8X
- : 8X → 4X → 1X

- When you change the magnification or the position to be displayed, the zoom position indication (A) appears for about 1 second to check the enlarged area.

Recorded pictures can be deleted during the review (Quick Deletion)



- Once deleted, pictures cannot be recovered.
- Multi pictures or all pictures can be deleted. Read P62 to operate them.

Taking Close-up Pictures [AF MACRO]

This mode allows you to take close-up pictures of the subject, e.g. When taking pictures of flowers.

You can take pictures approaching the subject at a distance up to 5 cm (0.16 feet) from the lens by rotating the zoom ring upmost to Wide (1×).

I Set the focus switch to [AF MACRO].

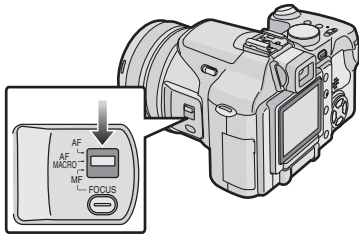

- We recommend using a tripod.
- When the subject is close to the camera, the effective focus range (depth of field) is significantly narrowed. Therefore, you will have difficulty in focusing on the subject if the distance between the camera and the subject is changed after focusing on the subject.
- When the camera lens is at a distance beyond the available range from the subject, the subject may not be focused even if the focus indication lights.
- The available flash range is about 30 cm (0.98 feet) to 7 m (23.0 feet) (Wide). (This is applied when you set the ISO sensitivity to [AUTO].)

■ Focus range

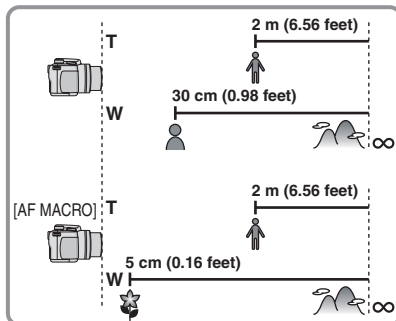

Taking Pictures with Manual Focus



Use this function when you want to fix the focus or when the distance between the lens and the subject is determined and you do not want to activate the auto focus.

- 1** Select [MF ASSIST] from the [SETUP] menu and set it to [MF1] or [MF2].

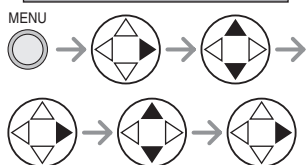
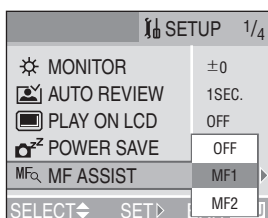

- Close the menu by pressing the shutter button halfway or the [MENU] button after finishing the setting.

- 2** Slide the focus switch to [MF] and rotate the focus ring **A** to focus on the subject.

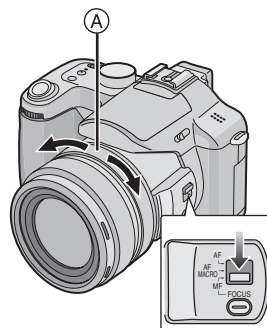

- 3** The MF assistance appears on the center of the screen.

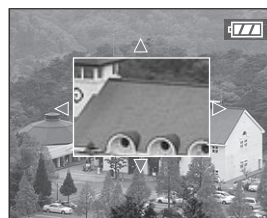

- When you stop rotating the focus ring, the MF assistance disappears about 2 seconds after.
- You can also set [MF ASSIST] to [OFF] on the [SETUP] menu.

■ MF ASSIST

When you rotate the focus ring while setting [MF ASSIST] to [MF1] or [MF2], the MF assistance is activated and the screen is enlarged. It allows you to focus on the subject more easily.

- [MF1]: The center of the screen is enlarged. You can adjust the focus while determining composition of the whole of the screen.
- [MF2]: The whole of the screen is enlarged. It is convenient for adjusting the focus in Wide.
- [OFF]: The screen is not enlarged.
- The MF assistance disappears in the following conditions.
 - When about 2 seconds have passed after you stop rotating the focus ring
 - When pressing the shutter button halfway

■ Technique for Manual focus

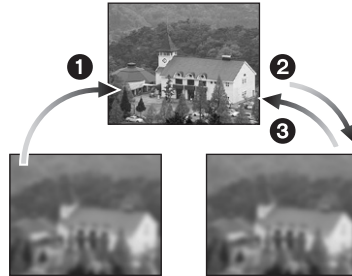

- ① Rotate the focus ring slowly.
- ② Rotate it little more.
- ③ Finely focus on the subject with rotating the focus ring reversely.

■ One shot AF

You can focus on the subject with auto focus by selecting [MF] with the focus switch and then sliding down the [FOCUS] button.

This is convenient for prefocus.

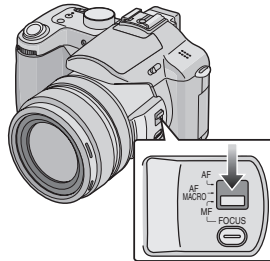

■ Prefocus

This is a technique to focus on the point to take pictures in advance when it is difficult to focus on the subject with auto focus due to its quick motion. [e.g. [PANNING] (P80) in scene mode]

This function is suitable when the distance between the camera and the subject is certain.

■ Changing the zoom area

The magnified area can be changed while the screen is expanded using MF Assist. This is convenient when you want to change the focus position to take pictures.

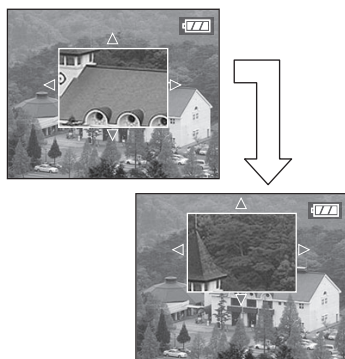

- 1 Rotate the Focus ring.
- 2 Press ▲/▼/◀/▶ to change the expanded area.
 - The expansion is canceled after approximately 2 seconds.
- The following will return the AF area to the original position.
 - Changing the Focus switch to [AF] or [AF MACRO].
 - Changing the picture size or aspect.
 - Turning the camera off.



- You can also record with manual focus in motion picture mode [M]. However the screen is not expanded while recording the motion picture.
- When you focus on the subject in Wide, the focus may not be adequate in Tele. In this case, focus on the subject again.
- When setting the manual focus, you cannot set the continuous AF (P90).
- **If you rotate the focus ring or zoom ring while recording motion pictures, recording pictures with audio or adding audio to recorded pictures, a grinding noise may be recorded.**

Taking Pictures using the Built-in Flash



When you set the flash, you can take pictures using the built-in flash according to the recording condition.

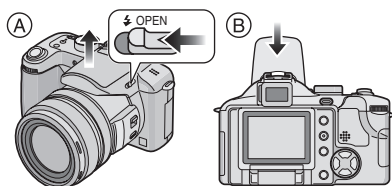

- (A) To open the flash**
Slide the [⚡ OPEN] lever.
- (B) To close the flash**
Press the flash until it clicks.
- Be sure to close the flash when not in use.
 - The flash setting is fixed to Forced OFF [🚫] while the flash is closed.

Switching to the appropriate flash setting



For the selectable flash settings, refer to “Available flash settings by recording mode” on P50.

⚡ A : AUTO

The flash is automatically activated according to the recording condition.

⚡ A 👁 : AUTO/Red-eye reduction

The flash is automatically activated according to the recording condition. It reduces the red-eye phenomenon (eyes of the subject appear red in the picture) by triggering the flash before actually recording the picture. After that, the flash is activated for actual recording again.

- The flash is activated twice. The first flash is activated only for a preparation of actual recording. The subject should not move until the second flash is finished.
- Use this when you take pictures of people in low lighting conditions.

⚡ : Forced ON

The flash is activated every time regardless of the recording condition.

- Use this when your subject is back-lit or under fluorescent light.

⚡ 👁 : Forced ON/Red-eye reduction

- The flash setting is set to Forced ON/Red-eye reduction only when you set to [CANDLE LIGHT] (P76) and [PARTY] (P77) in scene mode.

⚡ S 👁 : Slow sync./Red-eye reduction

When you take a picture with a dark background landscape, this feature makes the shutter speed slow when the flash is activated, so that the dark background landscape will become bright. Simultaneously it reduces the red-eye phenomenon.

- Use this when you take pictures of people in front of a dark background.

🚫 : Forced OFF

The flash is not activated in any recording condition.

- Use this when you take pictures in places where the use of the flash is not permitted.

Recording pictures (basic)

■ Available flash settings by recording mode

The available flash settings depend on the recording mode.

(○: Available, —: Not available)

	P	A	S	M	▲	■	☺	☺	☺	☺	☺	☺	☺	☺	☺	☺	☺	☺	☺	☺
	○	○	○	○	—	—	○	○	○	—	—	—	○	○	—	—	—	○	—	○
	○	○	○	○	○*	—	○	○	—	—	—	—	○	○	—	—	—	—	—	○
	○	○	○	○	○	—	○	○	○	—	—	—	○	○	—	—	—	○	—	○
	—	—	—	—	—	—	—	—	—	—	—	—	—	—	○	○	—	—	—	—
	○	○	—	—	—	—	—	—	—	—	○	—	—	—	○	○	—	—	—	—
	○	○	○	○	○	○	○	○	○	○	○	○	○	○	○	○	○	○	○	○

*Not available in backlight compensation

■ The available flash range to take pictures

ISO sensitivity	Available flash control range	
	Wide	Tele
AUTO	30 cm (0.98 feet) to 7.0 m (23.0 feet)	30 cm (0.98 feet) to 5.3 m (17.4 feet)
ISO80	30 cm (0.98 feet) to 3.2 m (10.5 feet)	30 cm (0.98 feet) to 2.4 m (7.87 feet)
ISO100	30 cm (0.98 feet) to 3.5 m (11.5 feet)	30 cm (0.98 feet) to 2.6 m (8.53 feet)
ISO200	40 cm (1.31 feet) to 5.0 m (16.4 feet)	40 cm (1.31 feet) to 3.8 m (12.5 feet)
ISO400	60 cm (1.97 feet) to 7.0 m (23.0 feet)	60 cm (1.97 feet) to 5.3 m (17.4 feet)

- The available flash range is an approximation.
- Refer to P38 for the focus range.
- Refer to P84 for the ISO sensitivity.



- If the ISO sensitivity is set to [AUTO], it is automatically adjusted from [ISO80] to [ISO400] when you use the flash.
- To avoid picture noise, we recommend setting [NOISE REDUCTION] in [PICT.ADJ.] to [HIGH] or setting the items except [NOISE REDUCTION] to [LOW] to take pictures. (P92)
- In motion picture mode [] and [SCENERY] (P73), [NIGHT SCENERY] (P74), [FIREWORKS] (P77) or [STARRY SKY] (P79) in scene mode, the flash setting is fixed to Forced OFF [] even if the flash is opened.

■ Shutter speed for each flash setting

Flash setting	Shutter speed (Sec)
: AUTO	1/30 to 1/2000
: AUTO/Red-eye reduction	1/30 to 1/2000
: Forced ON	1/30 to 1/2000
: Forced ON/Red-eye reduction	
: Slow sync./Red-eye reduction	1 to 1/2000
: Forced OFF	1/4 to 1/2000 (In auto mode)
	1 to 1/2000 (In program AE mode)

- Refer to P68 for the Aperture-priority AE, Shutter-priority AE or Manual exposure mode.
- There may be differences in the above shutter speeds in scene mode.
 - [NIGHT SCENERY] mode: 8 to 1/2000th
 - [BABY] mode (when using the flash): 1/30th to 1/2000th
 - [STARRY SKY] mode: 15 seconds, 30 seconds, 60 seconds

■ Adjusting flash output

Adjust the flash output when the subject is small or reflection ratio is extremely high or low.

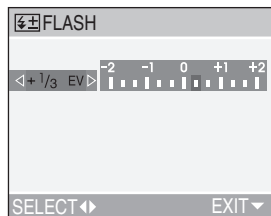

- In motion picture mode [], auto mode [] and [SCENERY] (P73), [NIGHT SCENERY] (P74), [FIREWORKS] (P77) or [STARRY SKY] (P79) in scene mode, you cannot adjust the flash output.

1 Press **▲** () several times until [FLASH] appears and then set the flash output.



- You can adjust this from -2 EV to +2 EV in steps of 1/3 EV.
- The flash output setting is memorized even if the camera is turned off.



- **Do not stare at the photo flash from close proximity.**
 - **Do not bring the flash too close to objects or close the flash while it is activated. The objects may be discolored by its heat or lighting.**
 - **Do not cover the photo flash with your fingers or any other items.**
 - The flash icon turns red when activating the flash and pressing the shutter button halfway.
 - When you take a picture beyond the flash control range, the exposure may not be adjusted properly and the picture may become bright or dark.
 - When you repeat taking a picture, recording may be disabled even if the flash is activated. Take a picture after the access indication disappears.
 - When the jitter alert appears, we recommend using the flash.
 - When you set to burst mode or auto bracket, only 1 picture is recorded for every flash activated.
 - When the flash is being charged, the flash icon blinks red, and you cannot take a picture even when you press the shutter button fully.
 - **When taking a picture with the flash, we recommend removing the lens hood. In some cases it may not allow the scene to be illuminated properly.**
 - Do not close the flash soon after the flash is activated prior to taking pictures due to AUTO/Red-eye reduction etc. It causes a malfunction.
 - When taking a picture with the flash, the white balance will be automatically adjusted [except for [] (Daylight) and [] (Flash)], but the white balance may not be properly adjusted if the flash level is insufficient.
 - When the shutter speed is fast, the flash effect may not be sufficient.
- Refer to P97 for information about extra flashes.
 - When using a conversion lens, the built-in flash setting is fixed to Forced OFF [].

Taking Pictures with the Self-timer



1 Select the self-timer mode.



: Self-timer set to 10 seconds

: Self-timer set to 2 seconds

No display: canceled

2 Take the picture.

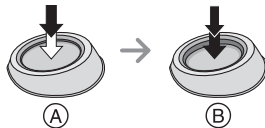

- (A): Press the shutter button halfway to focus.
- (B): Press the shutter button fully to take the picture.

- The self-timer indicator

blinks and the shutter is activated after 10 seconds (or 2 seconds).

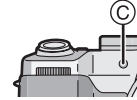

- If you press the [MENU] button when the self-timer is set, the self-timer setting is canceled.



- When using a tripod or in other cases, setting the self-timer to 2 seconds is a convenient way to avoid the jitter caused by pressing the shutter button.
- When you press the shutter button fully with one stroke, the subject is automatically focused just before the recording. In dark places, the self-timer indicator blinks and then it may turn on brightly to work as the AF assist lamp (P90) for focusing on the subject.
- When you set the self-timer in the burst mode, the camera starts taking a picture 2 or 10 seconds after the shutter button is pressed. The number of pictures taken at a time is fixed to 3.
- We recommend using a tripod when recording with the self-timer. (When you use a tripod, make sure the tripod is stable with the camera attached to it.)

Compensating the Exposure



Use this function when you cannot achieve appropriate exposure due to the difference of brightness between the subject and the background. Check the following for examples.

Under exposed

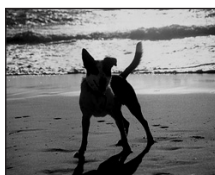

Compensate the exposure toward positive.



Properly exposed



Over exposed



Compensate the exposure toward negative.

1 Press **▲** () several times until [EXPOSURE] appears and then compensate the exposure.

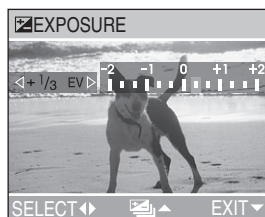

- You can compensate from -2 EV to $+2$ EV in steps of $1/3$ EV.





- EV is an abbreviation for Exposure Value, and it is the amount of light given to the CCD by the aperture value and the shutter speed.
- The compensation range of the exposure will be limited depending on the brightness of the subject.
- The exposure compensation value appears on the lower left of the screen.
- The set exposure value is memorized even if the camera is turned off.
- Exposure cannot be compensated when using [STARRY SKY] (P79) in scene mode.

Taking Pictures using Auto Bracket



In this mode, 3 pictures are automatically recorded by each press of the shutter button according to the compensation range of the exposure.

You can select the desired exposure among the 3 types of pictures.

1 Press \blacktriangle () several times until [] AUTO BRACKET appears and then set the compensation range of the exposure.

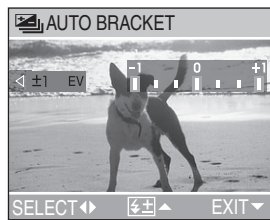

- You can select the exposure from -1 EV to $+1$ EV in steps of $1/3$ EV.
- When you do not use auto bracket, select [OFF].
- When setting the auto bracket, the auto bracket icon appears on the lower left of the screen.



- If the remaining number of recordable pictures is 2 or less, you cannot take pictures by setting auto bracket.
- When taking pictures using auto bracket after the exposure compensation, the pictures are based on the compensated exposure.
 - When the exposure is compensated, the compensated exposure value appears on the lower left of the screen.
- When the flash is activated or [STARRY SKY] (P79) in scene mode is selected, you can take only 1 picture.
- When the auto bracket is activated, [AUDIO REC.] cannot be used.
- When setting the quality to [TIFF] or [RAW], you cannot take pictures with the auto bracket.
- When setting auto bracket and the burst mode simultaneously, auto bracket will be performed.
- The exposure may not be compensated with auto bracket depending on the brightness of the subject.
- When setting the auto bracket, the auto review function is activated regardless of the setting on the auto review function. (The picture is not enlarged.) Moreover, the settings for the auto review function on the [SETUP] menu are disabled.
- The auto bracket setting is not canceled after turning the camera off.
- In shutter-priority AE and manual exposure, if the shutter speed is set to more than 1 second auto bracket is disabled.

Optical Image Stabilizer



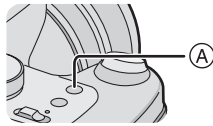

This mode recognizes and compensates jitter. You can reduce blurring caused by jitter especially when you take pictures with the optical zoom set to Tele or when you take pictures indoors where the shutter speed is slowed down.

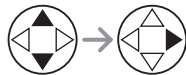
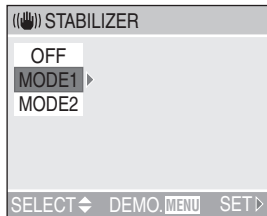

1 Press the optical image stabilizer button (A) until [STABILIZER] appears and then select the stabilizer function mode.



MODE1 ()	The stabilizer operates continuously and can assist during photo composition.
MODE2 ()	The stabilizer function is in standby and activates at the moment the shutter captures the image. This mode offers a greater degree of stabilization.
OFF ()	When image stabilization is not needed or when using the camera with a tripod.

■ Demonstration of the optical image stabilizer (Demonstration Mode)

When you press the [MENU] button, the demonstration appears. After the demonstration ends, the screen returns to the stabilizer function mode selection menu. If you want to exit the demonstration halfway through, press the [MENU] button again.

While the demonstration is displayed, you cannot take pictures.

While the demonstration is displayed, set the optical zoom to Wide (1×).



The stabilizer function may not work sufficiently in the following cases.

- When too much jitter occurs.
- When using the digital zoom.
- When taking pictures while following subjects in motion.
- When the shutter speed is extremely slow due to dark conditions or other reasons.

Be careful of jittering when pressing the shutter button.

- In [STARRY SKY] (P79) in scene mode, the stabilizer function is fixed to [OFF] and the stabilizer function menu does not appear.
- In motion picture mode [] and [PANNING] (P80) in scene mode, [MODE2] cannot be selected.

Taking Pictures using Burst Mode



1 Select the burst mode.

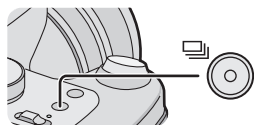
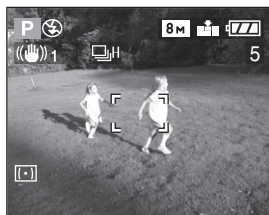

: High speed



: Low speed



: Unlimited*1



No display: canceled

*1 Depending on the memory size, battery power, picture size and quality (compression)

- Hold down the shutter button fully to activate the burst mode.

Number of pictures recorded in burst mode

	Burst speed (pictures/second)	Number of recordable pictures (pictures)	
	3*2	max. 5	max. 9
	2*2	max. 5	max. 9
	approx. 2	Depends on remaining capacity of the card	

*2 The burst speed is constant regardless of the transfer speed of the card.



- When the shutter speed is higher than 1/60 and the flash is not activated.



When the burst mode setting is set to Unlimited

- You can take pictures until the capacity of the card becomes full.
- Depending on the transfer speed of the card, the burst speed may become slower halfway.
- The focus is fixed at taking the first picture.
- When using the self-timer or an extra flash with burst mode, the number of recordable pictures is fixed at 3.
- When the burst mode is activated, [AUDIO REC.] cannot be used.
- When the flash is activated or [STARRY SKY] (P79) in scene mode is selected, you can take only 1 picture.
- When setting auto bracket and the burst mode simultaneously, auto bracket will be performed.
- You cannot take pictures in burst mode when the quality is set to [TIFF] or [RAW].

Recording pictures (basic)

- The ways to control the exposure and the white balance vary depending on the burst mode setting. When the burst speed is set to [], they are fixed to the values set for the first picture. When the burst speed is set to [] or [], they are adjusted each time you take a picture.
- When setting the burst mode, the auto review function is activated regardless of the setting on the auto review function. (The picture is not enlarged.) Moreover, the settings for the auto review function on the [SETUP] menu are disabled.
- Burst mode is not canceled when the camera is switched off.
- Burst mode will not perform as described if a MultiMediaCard is used in place of an SD Memory Card. The reading/writing speed of a MultiMediaCard is slower than that of an SD Memory Card.

Playing Back Pictures



I Select the picture.

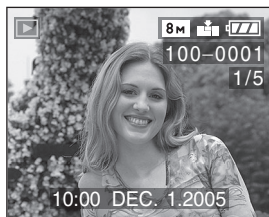

- ◀/▶ : Play back the previous picture.
- ▶/◀ : Play back the next picture.
- The last recorded picture will be played back first.
- When [ROTATE DISP.] (P104) is set to [ON], pictures recorded by holding the camera vertically are played back vertically.

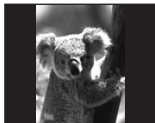

■ Fast forwarding/Fast rewinding

When you keep pressing ◀/▶ during playback, the file number and the page number are updated. If you release ◀/▶ when the number of the desired picture appears, you can play back the picture.

▶: Fast forward

◀: Fast rewind

- When you keep pressing ◀/▶, the number of files forwarded/rewound at a time is increased.

- If you release ◀/▶ and press them again, the files will be forwarded/rewound one by one.
- In review playback in the recording mode or multi playback, the picture can only be forwarded or rewound one by one.
- When you forward or rewind a large number of pictures, release ◀/▶ once before reaching the picture to be played back, then press ◀/▶ to forward/rewind pictures little by little.



- You can also select the previous or next picture with the rear dial.

- This camera is based on the DCF standard (Design rule for Camera File system) which was established by the Japan Electronics and Information Technology Industries Association (JEITA).
- When changing the folder name or file name on a PC, the pictures will not be played back.
- The file format that can be played back with the camera is JPEG. (Even JPEG pictures cannot be played back in some cases.)
- When playing back pictures that have been recorded with other equipment, the picture quality may deteriorate or the pictures may not play back.
- When playing back a non-standard file, the folder/file number is indicated by [—] and the screen may turn black.
- An interference fringe may appear on the screen depending on the subject. This is called moire. This is not a malfunction.

Multi Playback (9 screens, 16 screens, and 25 screens)



1 Rotate the front dial to the left to display multiple pictures.

(Screen when 9 screens are displayed)



- : 1 screen → 9 screens → 16 screens → 25 screens
- After switching to multi screen, rotate the front dial further to display 16 screens then 25 screens. Rotate the front dial to the right to return to the previous screen.
- When you switch to multi screen, the scroll bar **A** appears. From all the recorded pictures, the location of the displayed picture can be confirmed.

2 Select the pictures.



- The selected picture's recording date and number, the total number of recorded pictures, [★] a favorite, [RECALL]

a motion picture, [RECALL] in [BABY] in scene mode, age in months, age in years etc. are displayed.

Examples of 16 screens and 25 screens



ⓑ: 16 screens

ⓒ: 25 screens

To return to the normal playback

Rotate the front dial towards the right or press the [MENU] button.

- The picture framed in orange appears.

To delete a picture during a multi playback

Press the [DELETE] button.

When the confirmation screen appears, press ▼ to select [YES], and press ►. (P62)



- Pictures will not be displayed in the rotated direction even if [ROTATE DISP.] is set to [ON] (P104).
- You can switch whether you turn the indications on the LCD monitor on or off by pressing the [DISPLAY] button.

Using the Playback Zoom



1 Rotate the front dial towards the right to enlarge the picture.

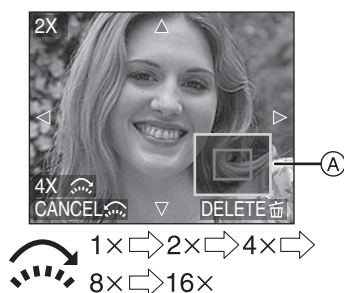

- When you rotate the front dial towards the left after the picture is enlarged, the magnification becomes lower. When you rotate the front dial towards the right, the magnification becomes higher.
- When you change the magnification, the zoom position indication (A) appears for about 1 second to check the position of the section enlarged.
- When you press the [MENU] button, the magnification reverts to 1×.

2 Shift the picture.



- When you move the position to be displayed, the zoom position indication is displayed for about 1 second.

■ To delete a picture during playback zoom

Press the [MENU] button.

When the confirmation screen appears, press ▼ to select [YES], and press ►. (P62)



- The more the picture is enlarged, the more its quality deteriorates.
- The playback zoom may not operate if pictures have been recorded with other equipment.
- Even if the indications on the screen are turned off in normal playback mode (P26), the magnification and enabled operations appear on the screen when the playback zoom is activated. You can switch whether you turn the indications on the LCD monitor on or off by pressing the [DISPLAY] button. When you set the magnification to 1×, the indications on the LCD monitor are displayed as in normal playback mode.

Deleting Pictures



■ To delete a single picture

1 Select the picture to be deleted.

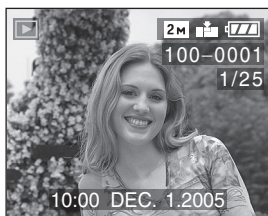

- ◀: Play back the previous picture.
- ▶: Play back the next picture.

2 Delete the picture.



- While deleting the picture, [] appears on the screen.

■ To delete [MULTI DELETE]/ [ALL DELETE]

1 Select [MULTI DELETE] or [ALL DELETE].

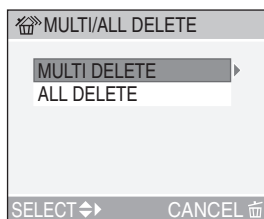

2 times

- If you selected [MULTI DELETE], do steps 2 and 3. (P63).
- If you selected [ALL DELETE], do step 3. (P63).

2 Select the pictures to be deleted. (Only when selecting [MULTI DELETE])



- Repeat the above procedure.
- The selected pictures appear with [🗑️]. When ▼ is pressed again, the setting is canceled.
- After selecting pictures, press [🗑️] to delete.
- The icon [🔒] blinks red if the selected picture is protected and cannot be deleted. Cancel the protect setting (P108), then delete the picture.

3 Delete the pictures. (Screen when selecting [MULTI DELETE])

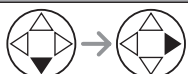

- When using [ALL DELETE], [DELETE ALL PICTURES?] is displayed.



- When [FAVORITE] (P103) is set to [ON], [ALL DELETE EXCEPT ★] appears in the [MULTI/ALL DELETE] screen. All the pictures not set as favorites can be deleted if you select [ALL DELETE EXCEPT ★] and use the same steps as [ALL DELETE]. However, if none of the pictures have [★] displayed, you cannot select [ALL DELETE EXCEPT ★] even if [FAVORITE] is set to [ON].
- Once deleted, pictures cannot be recovered. Please double-check before deleting pictures.
- Do not turn off the camera while deleting.
- When you delete pictures, use a battery with sufficient battery power (P13) or use the AC adaptor (DMW-CAC1; optional).
- It is possible to delete up to 50 pictures at once using [MULTI DELETE].
- The more pictures these are the longer it will take to delete.
- Pictures that are protected [🔒] (P108) or do not conform to the DCF standard (P59) will not be deleted even if [ALL DELETE] or [ALL DELETE EXCEPT ★] are selected.

Using the Mode Dial

A Aperture-priority AE



When you want the background to be in sharp focus, set the aperture value to a higher number. The higher the aperture value is the smaller the aperture opening will be. For a soft focus background, set the aperture value to a lower number which corresponds to a larger aperture opening.

1 Set the aperture value and take the picture.



- Refer to P68 for the available range of the aperture value and the shutter speed.
- If the subject is too bright, set to a larger aperture value, if too dim, set to a smaller aperture value.
- The brightness of the screen may differ from that of the actual pictures. Check it using review function or setting to the playback mode.
- The ISO sensitivity cannot be set to [AUTO]. (P84) (When the recording mode is switched to Aperture-priority AE, the ISO sensitivity is automatically set to [ISO100] even though it was set to [AUTO] beforehand. You can also change ISO setting from [ISO80], [ISO200] or [ISO400] on the menu.)
- When the exposure is not adequate, the aperture value and the shutter speed on the screen turn red.

S Shutter-priority AE

S

When you want to take a sharp picture of a fast moving subject, set with a faster shutter speed. When you want to create a trail effect, set to a slower shutter speed.

1 Set the shutter speed and take the picture.

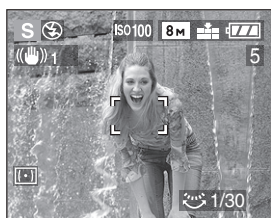

- Refer to P68 for the available range of the aperture value and the shutter speed.
- The brightness of the screen may differ from that of the actual pictures. Check it using review function or setting to the playback mode.
- You cannot set the following items in Shutter-priority AE.
 - Slow sync./Red-eye reduction [**⚡S**] (P49)
 - [AUTO] in ISO sensitivity (P84) (When the recording mode is switched to Shutter-priority AE, the ISO sensitivity is automatically set to [ISO100] even though it was set to [AUTO] beforehand. You can also change ISO setting from [ISO80], [ISO200] or [ISO400] on the menu.)
- When the exposure is not adequate, the aperture value and the shutter speed on the screen turn red.
- When the shutter speed is slow, we recommend using a tripod.

M Manual exposure



Decide on an exposure by setting the aperture value and the shutter speed manually.

1 Set the aperture value and the shutter speed.



- : Aperture value
- : Shutter speed

2 Press the shutter button halfway.

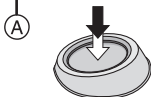

- Indication for the condition of exposure (A) (manual exposure assistance) appears for about 10 seconds.
- When the exposure is not adequate, set the aperture value and the shutter speed again.

3 Take the picture.

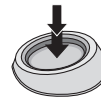

Manual Exposure Assistance

	The exposure is adequate.
	Set to faster shutter speed or larger aperture value.
	Set to slower shutter speed or smaller aperture value.

- The manual exposure assistance is an approximation. We recommend taking pictures and then checking them using the review function.



- Refer to P68 for the available range of the aperture value and the shutter speed.
- The brightness of the screen may differ from that of the actual pictures. Check it using review function or setting to the playback mode.
- If the exposure is not adequate, the aperture value and the shutter speed turn red when pressing the shutter button halfway.
- You cannot set the following items in manual exposure.
 - Slow sync./Red-eye reduction [] (P49)
 - [AUTO] in ISO sensitivity (P84) (When the recording mode is switched to Manual exposure, the ISO sensitivity is automatically set to [ISO100] even though it was set to [AUTO] beforehand. You can also change ISO setting from [ISO80], [ISO200] or [ISO400] on the menu.)
 - Exposure compensation (P54)
- Please set [HIGHLIGHT] to [ON] on the [SETUP] menu (P24) while the auto review or review function is activated. Any white saturated area on the picture will appear blinking in black and white. Adjust the aperture value or shutter speed to compensate for a better exposure.

■ Aperture Value and Shutter Speed

Aperture-priority AE

Available Aperture Value (Per 1/3 EV)			Shutter Speed (Sec)
F8.0 to F11.0			8 to 1/2000
F7.1	F6.3	F5.6	8 to 1/1600
F5.0	F4.5	F4.0	8 to 1/1300
F3.6	F3.2	F2.8	8 to 1/1000

Shutter-priority AE

Available Shutter Speed (Sec) (Per 1/3 EV)				Aperture Value
8	6	5	4	F2.8 to F11.0
3.2	2.5	2	1.6	
1.3	1	1/1.3	1/1.6	
1/2	1/2.5	1/3.2	1/4	
1/5	1/6	1/8	1/10	
1/13	1/15	1/20	1/25	
1/30	1/40	1/50	1/60	
1/80	1/100	1/125	1/160	
1/200	1/250	1/320	1/400	
1/500	1/640	1/800	1/1000	
1/1300				
1/1600				F5.6 to F11.0
1/2000				F8.0 to F11.0

Manual exposure

Available Aperture Value (Per 1/3 EV)	Available Shutter Speed (Sec) (Per 1/3 EV)
F2.8 to F3.6	60 to 1/1000
F4.0 to F5.0	60 to 1/1300
F5.6 to F7.1	60 to 1/1600
F8.0 to F11.0	60 to 1/2000



- The aperture values in the table above are the values when the zoom ring is rotated to Wide at maximum.
- Some of the aperture values cannot be selected depending on the zoom magnification.

Motion picture mode



This mode allows you to record motion pictures with audio.

1 Select [PICT.MODE].

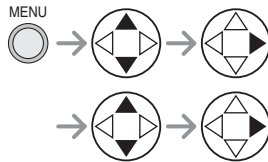
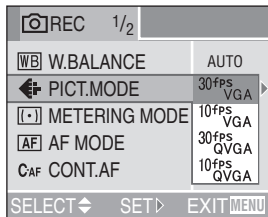

- Close the menu by pressing the shutter button halfway or the [MENU] button after finishing the setting.

	Picture size	fps (frame/second)
30fpsVGA	640×480 pixels	30
10fpsVGA		10
30fpsQVGA	320×240 pixels	30
10fpsQVGA		10

- You can record smoother motion pictures with [30fpsVGA] and [30fpsQVGA].
- You can record motion pictures for longer periods with [10fpsVGA] and [10fpsQVGA] although the picture quality is lower.
- Since the file size of [10fpsQVGA] is small, it is suitable for e-mails.
- fps (frame per second); This refers to the number of frames used in 1 second.

2 Press the shutter button halfway.

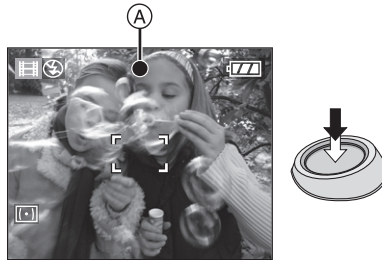

- When the subject is focused, the focus indication (A) lights.

3 Press the shutter button fully to start the recording.

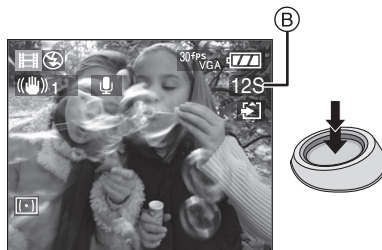

- The remaining recording time (B) (approx.) is displayed.
- The audio recording starts simultaneously from the built-in microphone of the camera.
- By pressing the shutter button fully again, the recording stops.
- If the card becomes full during recording, the camera stops automatically.

Recording pictures (advanced)

■ Available recording time (seconds)

SD Memory Card	Picture quality setting			
	30fps VGA	10fps VGA	30fps QVGA	10fps QVGA
16 MB	5	25	25	82
32 MB	16	58	58	175
64 MB	38	120	120	360
128 MB	82	250	250	740
256 MB	160	490	490	1440
512 MB	320	980	980	2870
1 GB	660	1970	1970	5700
2 GB	1350	4020	4020	11700

- The recordable time is an approximation. (It varies depending on the recording condition and the types of SD memory Card.)
- The recording time changes with subjects.
- The available recording time displayed on the LCD monitor may not reduce regularly.
- This unit does not support MultiMediaCard for recording motion pictures.



- The motion pictures cannot be recorded without audio.
- The settings for auto focus and the aperture value are fixed to what they are when recording starts (in the first frame).
- Depending on the type of card, the card access indication appears for a while after recording motion pictures. However, this is not a malfunction.
- When you set the picture quality to [30fpsVGA], we recommend using a high speed SD Memory Card with “10 MB/s” or greater displayed on the package.
- **Depending on the number of pictures, type of card and number of pictures deleted, recording may stop in the middle when you are recording. If something like this happens, clean-up may be effective. We recommend you clean up the card using the camera in advance. (P114)**

• **We recommend using Panasonic’s SD Memory Card. (Use only the genuine SD card with SD Logo.)**

- When motion pictures recorded with the camera are played back on other equipment, the quality of pictures and sounds may be deteriorated or it may not be possible to play them back.
- Motion pictures recorded with setting to [30fpsVGA], [30fpsQVGA] or [10fpsVGA] on this camera cannot be played back on equipment which does not support these settings.
- In motion picture mode [], you cannot use the direction detection function and the review function.
- You cannot set [MODE2] on the optical image stabilizer function.
- **If you rotate the focus ring or zoom ring while recording motion pictures, a grinding noise may be recorded.**
- Please note that the bundled software includes QuickTime to play back motion picture files created with the camera on the PC.

SCN [SCENE MODE] menu

SCN1 SCN2

Press the [MENU] button to display the [SCENE MODE] menu. When [AUTO] is setting for [SCENE MENU] (P24) on the [SETUP] menu, setting the mode dial to [SCN1] or [SCN2] will display to menu automatically.

Menu items

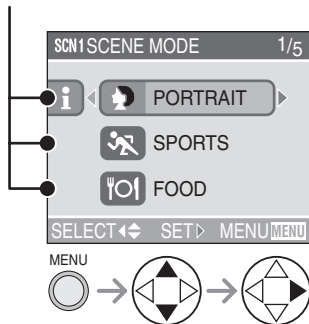

- When you press ◀, the explanations for each scene mode are displayed. (When you press ▶, the screen returns to the [SCENE MODE] menu.)
- Rotate the front dial to switch between pages 1/5, 2/5, 3/5, 4/5 and 5/5.
- If you press the [MENU] button while the [SCENE MODE] menu is displayed, you can set the [REC] mode menu (P81) and the [SETUP] menu (P21).
- This mode also allows you to set [SCENE MENU] (P24) on the [SETUP] menu to [OFF] and set the scene mode which are frequently used to [SCN1] and [SCN2] on the mode dial. It is convenient because you can select the scene mode quickly and minimize the operation.

- ▶ : [PORTRAIT] (P72)
- ▶ : [SPORTS] (P72)
- ▶ : [FOOD] (P73)
- ▶ : [SCENERY] (P73)
- ▶ : [NIGHT PORTRAIT] (P74)
- ▶ : [NIGHT SCENERY] (P74)
- ▶ : [BABY] (P75)
- ▶ : [SOFT SKIN] (P76)
- ▶ : [CANDLE LIGHT] (P76)
- ▶ : [PARTY] (P77)
- ▶ : [FIREWORKS] (P77)
- ▶ : [SNOW] (P78)
- ▶ : [STARRY SKY] (P79)
- ▶ : [PANNING] (P80)



- The camera automatically determines the appropriate focus in each scene mode and this is not affected by the focus switch setting. (Even if the focus switch is set to [AF MACRO], the AF MACRO icon does not appear.) Depending on the scene, the camera may not focus properly when you take close-up pictures. Select the appropriate scene for the recording situation.
- When you take pictures with a scene mode which is not adequate for the purpose, the hue may differ from the actual scene.
- When you want to change the brightness of the picture to be recorded, compensate the exposure (P54). (However, the exposure cannot be compensated in [STARRY SKY].)
- When you use a flash in scene mode, use the built-in flash.
- The following functions cannot be set in scene mode.
 - White balance (P82)
 - ISO sensitivity (P84)
 - Color effect (P91)
 - Picture adjustment (P92)

[SCENE MODE] menu (Refer to P71 for information about how to select the menu.)

Portrait mode

Select this mode when you want to take pictures of people.

This mode allows you to make the subject stand out from an unfocused background and adjust the exposure and the hue to achieve a healthy complexion on the subject.

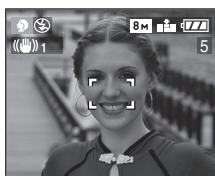

■ **Technique for Portrait mode**

To make this mode more effective:

- 1 Rotate the zoom ring to Tele as far as possible.
- 2 To maximize the effect, select a background as far as possible from the camera, and get closer to the subject.



- This mode is only suitable for outdoors in the daytime.
- The ISO sensitivity is fixed to [AUTO].

Sports mode

This mode allows you to take pictures of a fast moving subject. (e.g. When taking pictures of outdoor sports.) Set the focus switch to [AF].

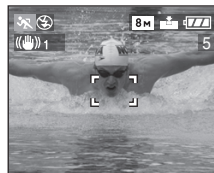

■ **Technique for Sports mode**

To take a sharp picture of a fast moving subject, the shutter speed becomes faster than usual. This mode is more effective when taking pictures in the daytime on a clear day.



- This mode is suitable for outdoors only in the daytime, keeping 5 m (16.4 feet) or more away from the subject.
- The ISO sensitivity is fixed to [AUTO].

[SCENE MODE] menu (Refer to P71 for information about how to select the menu.)

 **Food mode**

Select this mode when you want to take pictures of food without being affected by the ambient light, such as at restaurants. This mode allows you to take pictures of food in a natural hue.

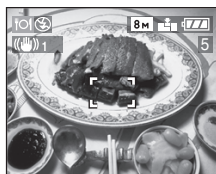

- The ISO sensitivity is fixed to [AUTO].

 **Scenery mode**

This mode allows you to take a picture of a wide landscape. The camera focuses on a distant subject preferentially. Set the focus switch to [AF].



- The focus range is 5 m (16.4 feet) to ∞ .
- The flash setting is fixed to Forced OFF [].
- The ISO sensitivity is fixed to [AUTO].
- The setting on the AF assist lamp is disabled.

[SCENE MODE] menu (Refer to P71 for information about how to select the menu.)

 **Night portrait mode**



This mode allows you to take pictures against a night landscape. The subject can be recorded with brightness in real life by using the flash and slowing down the shutter speed.



■ **Technique for Night portrait mode**

- **Use the flash. (P49)**
- Since the shutter speed becomes slow, we recommend using a tripod and the self-timer (P53) for taking pictures.
- Keep the subject still for about 1 second when taking a picture.
- We recommend taking pictures with zoom set to Wide (1×) and a distance of about 1.5 m (4.92 feet) from the subject.



- The focus range is 1.2 m (3.94 feet) to 5 m (16.4 feet).
(Refer to P50 for the flash control range.)
- Be sure to close the flash when not in use.
- The shutter may be kept closed (max. about 1 sec.) after taking a picture because of signal conditioning, but it is not a malfunction.
- When you take pictures in dark places, noise may become visible.
- When the flash is set, the flash setting is fixed to Slow sync./Red-eye reduction [ ] and the flash is always activated.
- The ISO sensitivity is fixed to [AUTO].
- The setting on the continuous AF is disabled.

 **Night scenery mode**

This mode allows you to take a picture of a nightscape. The landscape can be recorded vividly by slowing down the shutter speed. Set the focus switch to [AF].

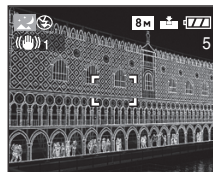

■ **Technique for Night scenery mode**

- Since the shutter speed becomes slow (max. about 8 sec.), use a tripod. We also recommend using the self-timer (P53) for taking pictures.



- The focus range is 5 m (16.4 feet) to ∞.
- The shutter may be kept closed (max. about 8 sec.) after taking a picture because of signal conditioning, but it is not a malfunction.
- When you take pictures in dark places, noise may become visible.
- The flash setting is fixed to Forced OFF [].
- The ISO sensitivity is fixed to [ISO80].
- The settings on the AF assist lamp and the continuous AF are disabled.

[SCENE MODE] menu (Refer to P71 for information about how to select the menu.)

 Baby mode

Select this mode when you want to take pictures of baby. Exposure and hue are adjusted to achieve a healthy complexion on the baby. When the flash is used, the light is weaker than usual.

- When playing back pictures, baby's age can be displayed.
- The age can also be printed on each picture by using the software [LUMIX Simple Viewer] or [PHOTOfunSTUDIO-viewer-] in the CD-ROM (supplied). (For information about printing, refer to the separate operating instructions for connecting to a PC.)

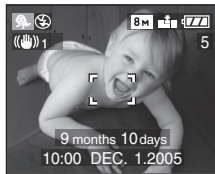

Age display setting

- If you want to display the age, set birthday in advance, select [WITH AGE] and press **▶**.
- If you do not want to display the age, select [WITHOUT AGE] and press **▶**.

Birthday setting

- 1 Select [BIRTHDAY SET.] and press **▶**.
 - 2 When a message [PLEASE SET THE BIRTHDAY OF THE BABY] appears, select items (year, month and day) using **◀/▶**, and set using **▲/▼**.
 - 3 Press the [MENU] button to finish the setting.
- If you select [WITH AGE] without setting birthday in advance, a message is displayed. Press the [MENU] button, and set birthday following the above steps 2 and 3.



- The ISO sensitivity is fixed to [AUTO].
- After turning on the camera in [BABY] or switching to [BABY] from other modes, the age and current date and time are displayed for about 5 seconds at the bottom of the screen.
- The age display style differs depending on the language setting in the recording mode.
- The date of birth is displayed as [0 month 0 day].
- If the age is not properly displayed, check the clock and birthday settings.
- If the camera is set to [WITHOUT AGE], the age is not recorded even the time and birthday are set. This means that the age cannot be displayed even if you set the camera to [WITH AGE] after taking pictures.
- For resetting the birthday setting, use [RESET] in the [SETUP] menu (P24).

[SCENE MODE] menu (Refer to P71 for information about how to select the menu.)

 **Soft skin mode**

Select this mode when you want to take a bust image of the subject. In this mode, camera detects a skin-color area, such as face, to achieve a smooth appearance of the skin.



■ **Technique for Soft skin mode**

To make this mode more effective:

- 1 Rotate the zoom ring to Tele as far as possible.
- 2 To maximise the effect, select a background as far as possible from the camera, and get closer to the subject.



- This mode is only suitable for outdoors in the daytime.
- The ISO sensitivity is fixed to [ISO80].
- If there is a color close to the skin color in the background, that part is also smoothened.
- This mode may not be effective in insufficient brightness.

 **Candle light mode**



Use this mode when you want to take photos with a candle light atmosphere.



■ **Technique for Candle light mode**

- By making the most of the candle light, you can take successful pictures without using the flash.
- We recommend using a tripod and the self-timer (P53) for taking pictures.



- The flash setting can be set to Slow sync./ Red-eye reduction [] or Forced ON/ Red-eye reduction [].
- The ISO sensitivity is fixed to [AUTO].

[SCENE MODE] menu (Refer to P71 for information about how to select the menu.)

 **Party mode**

This mode allows you to take a picture according to the atmosphere of the situation (e.g. a wedding reception, a party in a dark room, etc.).



Both the people and the background can be recorded with brightness in real life by using the flash and slowing down the shutter speed.



■ **Technique for Party mode**

- **Open the flash. (P49)**
- Since the shutter speed becomes slow, we recommend using a tripod and the self-timer (P53) for taking pictures.
- We recommend taking pictures with zoom set to Wide (1×) and a distance of about 1.5 m (4.92 feet) from the subject.



- The flash setting can be set to Slow sync./ Red-eye reduction [] or Forced ON/ Red-eye reduction [].
- The ISO sensitivity is fixed to [AUTO].

 **Fireworks mode**

This mode allows you to take beautiful pictures of fireworks exploding in the night sky. The shutter speed or the exposure is automatically adjusted for taking pictures of fireworks.

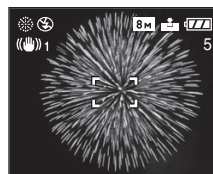

■ **Technique for Fireworks mode**

We recommend following the prefocus procedure below to ensure that you do not miss the chance to take pictures.

- 1 Set the focus switch to [MF] (P46)
 - 2 Aim the camera at an object (such as illumination on a building), which is roughly the same distance as the point of fireworks.
 - 3 Press the [FOCUS] button until the focus indication (P37) lights.
 - 4 Aim the camera at the direction where the fireworks will be exploding.
 - 5 Press the shutter button fully when fireworks are exploding.
- When you zoom away from or towards the subject, repeat steps 2 to 5 since the focus position becomes misaligned.
 - We recommend using a tripod.

[SCENE MODE] menu (Refer to P71 for information about how to select the menu.)



- When the auto focus is activated, the available recording range is 5 m (16.4 feet) to ∞. (We recommend following steps 1 to 5 on the previous page to take pictures with autofocus.)
- The flash setting is fixed to Forced OFF [OFF].
- The ISO sensitivity is fixed to [AUTO].
- The settings on the AF assist lamp and the continuous AF are disabled.



Snow mode

This mode allows you to take a picture in locations such as skiing resorts and locations near snowy mountains. The exposure and the white balance are adjusted to make the white color of the snow stand out.



- The ISO sensitivity is fixed to [AUTO].

[SCENE MODE] menu (Refer to P71 for information about how to select the menu.)

 *Starry sky mode*

This mode allows you to take beautiful pictures of a starry sky or a dark subject that you could not take with [NIGHT SCENERY]. It is possible to take clear pictures of stars in the night sky by making the shutter speed slower. Select a shutter speed of [15 SEC.], [30 SEC.] or [60 SEC.].

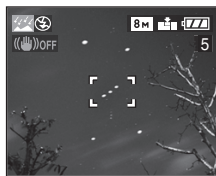

Setting the shutter speed

Press ▲/▼ to select the exposure time and press ►.

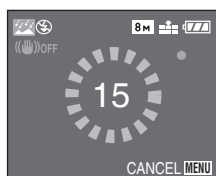
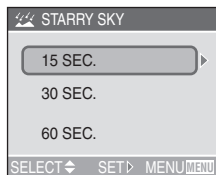

- Press the shutter button until the countdown screen is displayed. Do not move the camera after this screen is displayed. When countdown finishes, [PLEASE WAIT] is displayed for the same length of time as the set shutter speed for signal processing.

- If you press the [MENU] button while the picture is being taken, the picture will stop being taken.

■ Technique for Starry sky mode

- The shutter opens for 15, 30 or 60 seconds. Be sure to use a tripod. Moreover, taking pictures with the self-timer is recommended. (P53)



- The optical image stabilizer function is fixed to [OFF].
- The setting on the continuous AF is disabled.
- The flash setting is fixed to Forced OFF [].
- The ISO sensitivity is fixed to [ISO80].
- You cannot compensate the exposure or set auto bracket, burst mode or [AUDIO REC.]
- Histograms are always displayed in orange. (P30)

[SCENE MODE] menu (Refer to P71 for information about how to select the menu.)

 Panning mode

When you take a picture following the motion of a subject which moves in a certain direction such as a runner or a car, the background will show some motion blur. This special effect is called “panning”. This mode allows you to obtain this effect easier.



■ Technique for Panning mode

To achieve good pictures in panning mode, pick a horizontal plane—and then pan as you fire shots.

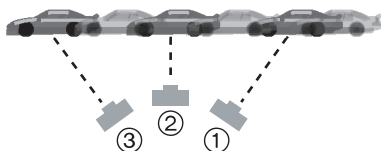

- ① Move the camera smoothly while tracking a subject in motion.
- ② Press the shutter button while moving the camera.
- ③ Keep moving the camera continuously.

• Be careful of the following:

- Use the Viewfinder. (P25)
- Select a subject with quick motion.
- Prefocus to the point where the subject will arrive. (P48)
- Use this mode with burst mode. (P57)
Select the best picture from the pictures taken.



- In panning mode, the shutter speed becomes slower than usual to achieve the panning effect. As a result, jitter can easily occur.
- Panning function does not work well in the following situations.
 - Very bright scenes such as daytime in summer. We recommend using an ND filter (DMW-LND55; optional). (P126)
 - When the shutter speed is faster than 1/100th.
 - When the subject moves slowly and the tracking speed is too slow. (The background cannot be recorded dynamically.)
- You cannot set the stabilizer function mode to [MODE2]. When [MODE1] is selected, only vertical jitters can be compensated in panning mode.
- The ISO sensitivity is fixed to [ISO80].
- The settings on the AF assist lamp and the continuous AF are disabled.

Using the [REC] mode menu



Setting the hue, picture quality adjustment, etc. allows you to create wide variations on taking pictures.

- Set the mode dial to the desired recording mode.

Menu items

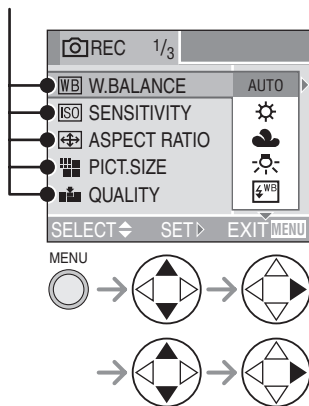

- Rotate the front dial to switch between pages 1/3, 2/3 and 3/3.
- When an extra flash is attached, the pages switch between 1/4, 2/4, 3/4 and 4/4.
- Close the menu by pressing the shutter button halfway or the [MENU] button after finishing the setting.

WB : [W.BALANCE] (P82)

ISO : [SENSITIVITY] (P84)

ASPECT RATIO : [ASPECT RATIO] (P84)

PICT.SIZE : [PICT.SIZE] (P85)

QUALITY : [QUALITY] (P86)

AUDIO REC. : [AUDIO REC.] (P87)

METERING MODE : [METERING MODE] (P87)

AF : [AF MODE] (P88)

CONT.AF : [CONT.AF] (P90)

AF* : [AF ASSIST LAMP] (P90)

D.ZOOM : [D.ZOOM] (P91)

COL.EFFECT : [COL.EFFECT] (P91)

PICT.ADJ. : [PICT.ADJ.] (P92)

FLIP ANIM. : [FLIP ANIM.] (P92)

CONVERSION : [CONVERSION] (P95)

EXT.FLASH : [EXT.FLASH] (P97) (Displayed when an extra flash is attached)







EX.FLASH BURST : [EX.FLASH BURST] (P99) (Displayed when an extra flash is attached)

[REC] mode menu (Refer to P81 for the setting method.)

[WB] White Balance [W.BALANCE]

P A S M

This function allows you to reproduce a white color closer to the tone in real life on the pictures recorded under sunlight, halogen lighting, etc. in which the white color may appear reddish or bluish.

AUTO	for auto setting (auto white balance)
 (Daylight)	for recording outdoors on a bright day
 (Cloudy)	for recording outdoors on a cloudy day
 (Halogen)	for recording under halogen lighting
 (Flash)	for taking a picture with flash only
 (White set 1)	for using the preset white balance
 (White set 2)	
 SET (White set)	for setting the white balance again (P83)

- When setting the white balance to the mode except [AUTO], you can finely adjust the white balance.

■ Auto White Balance

Use of auto white balance adjustment in inappropriate lighting conditions may result in reddish or bluish pictures. Where the subject is surrounded by many light sources, auto white balance adjustment may not operate properly.

In this case, set the white balance to a mode except [AUTO] manually.



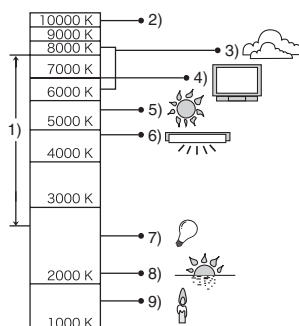

- 1 The range that is controlled by the auto white balance adjustment mode of the camera
- 2 Blue sky
- 3 Cloudy sky (Rain)
- 4 TV screen
- 5 Sunlight
- 6 White fluorescent light
- 7 Incandescent light bulb
- 8 Sunrise and sunset
- 9 Candlelight



K=Kelvin Color Temperature

■ Setting the White Balance manually (White set)





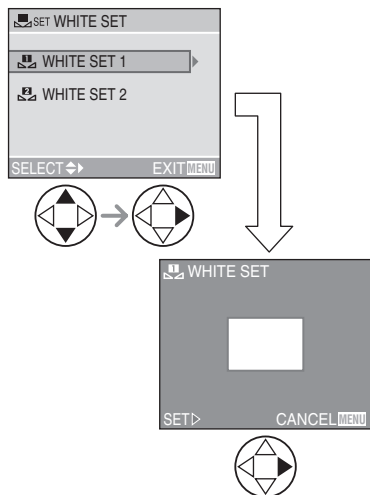

Use this mode when you want to set the white balance manually.

- 1 Set to [ SET] (White set), select [ WHITE SET 1] or [ WHITE SET 2] and then press .
- 2 Aim the camera at a sheet of white paper or a similar white object so that the frame in the center is filled by the white object and then press .





■ Finely Adjusting the White Balance (White Balance Fine Adjustment)

When you cannot acquire the desired hue by setting the white balance, you can adjust the white balance finely.

- 1 Set the white balance to [] / [] / [] / []. (P82)
- 2 Press  () several times until [WB ADJUST.] appears.





- 3 Finely adjust the white balance.

-  [BLUE]: Press when the hue is reddish.
-  [RED]: Press when the hue is bluish.



About the white balance

- In auto mode [], the white balance is fixed to [AUTO].
- When taking a picture with the flash, the white balance will be automatically adjusted [except for [] (Daylight) and [] (Flash)], but the white balance may not be properly adjusted if the flash level is insufficient.

About the white balance fine adjustment

- The white balance icon on the screen turns red or blue.
- You can set the value independently for each of the modes in white balance.
- The setting on the fine adjustment of the white balance is reflected to the picture when taking a picture with the flash.
- When you set the white balance using the White set [ SET], the adjustment level is set to "0".
- When the color effect is set to any of [COOL], [WARM], [B/W] or [SEPIA] (P91), you cannot finely adjust the white balance.

[REC] mode menu (Refer to P81 for the setting method.)**ISO ISO Sensitivity [SENSITIVITY]****PASM**

ISO sensitivity represents the sensitivity to light in values. If you set the ISO sensitivity higher, the camera becomes more suitable for recording in dark places.

- When setting to [AUTO], the ISO sensitivity is automatically adjusted from [ISO80] to [ISO200] according to the brightness. (It can be adjusted from [ISO80] to [ISO400] when using the flash.)

ISO sensitivity	80 ←————→ 400	
Use in bright places (e.g. outdoors)	Suitable	Not suitable
Use in dark places	Not suitable	Suitable
Shutter speed	Slow	Fast
Noise	Less	Increased





- In auto mode [**A**], motion picture mode [**M**] and scene mode (P71), ISO sensitivity is fixed to [AUTO]. (In [NIGHT SCENERY] (P74), [SOFT SKIN] (P76), [STARRY SKY] (P79) and [PANNING] (P80) in scene mode, it is fixed to [ISO80].)
- You cannot select [AUTO] in Aperture-priority AE, Shutter-priority AE and Manual exposure mode.
- To avoid picture noises, we recommend reducing the ISO sensitivity, setting [NOISE REDUCTION] in [PICT.ADJ] to [HIGH] or setting the items except [NOISE REDUCTION] to [LOW] to take pictures. (P92)
- Refer to P68 for the shutter speed.

Aspect Ratio [ASPECT RATIO]**PASM** **SCN1** **SCN2** **A**

The aspect ratio is the horizontal to vertical ratio of a picture.

You can select from three aspect ratios depending on a purpose.

4:3	Normal ratio. 
3:2	The screen becomes slight oblong in shape. Pictures are taken using the 3:2 aspect ratio, the same as for 35 mm film. 
16:9	The picture is horizontally long. This is suited for landscapes and other subjects that you prefer a wide view. This is also suited for playing back on wide-screen TVs and high-definition TVs. 



- The ends of the recorded pictures may be cut at printing. Check the picture in advance. (P135)

[REC] mode menu (Refer to P81 for the setting method.)** Picture Size [PICT.SIZE]**

When you select a larger picture size [**8M**] (8M), you can print pictures clearly.

If a small number of pixels [**1M**] (1M EZ) is selected, the size of the data will be small, so more images can be recorded. When attaching pictures to e-mail or using them on websites, resize the picture with [RESIZE] (P110).

■ When the aspect ratio is [4:3**].**

8M (8M)	3264×2448 pixels
5M (5M EZ)	2560×1920 pixels
3M (3M EZ)	2048×1536 pixels
2M (2M EZ)	1600×1200 pixels
1M (1M EZ)	1280×960 pixels

■ When the aspect ratio is [3:2**].**

7M (7M)	3248×2160 pixels
4.5M (4.5M EZ)	2560×1712 pixels
2.5M (2.5M EZ)	2048×1360 pixels

■ When the aspect ratio is [16:9**].**

5.5M (5.5M)	3072×1728 pixels
2M (2M EZ)	1920×1080 pixels





- EZ is an abbreviation for [Extended Optical Zoom]. Selecting a picture size with EZ displayed, allows you to magnify the subject up to a maximum of 19.1 times when the digital zoom is set to [OFF]. (P34)
- In the motion picture mode [**M**], the picture size is fixed to 640×480 pixels (VGA) or 320×240 pixels (QVGA).
- When a flip animation is created, the picture size is fixed to 320×240 pixels.
- Pictures may appear like a mosaic depending on the subject or the recording condition.

- The number of recordable pictures depends on the subject.
- The number of remaining pictures displayed on the screen may not correspond with recorded frames.
- Refer to P31 for the number of recordable pictures.

[REC] mode menu (Refer to P81 for the setting method.) **Quality [QUALITY]**

You can select 4 types of quality (compression level) according to the usage of the picture.

TIFF	TIFF (Uncompressed): This type is suitable when editing and processing pictures with retouch software.
	Fine (Low compression): This type gives priority to picture quality. Picture quality will be high.
	Standard (High compression): This type gives priority to the number of recordable pictures and records standard quality pictures.
RAW	RAW file: Set this when altering the pictures on a PC.



- When the quality is set to [RAW], the digital zoom cannot be used.
- When the quality is set to [TIFF], a JPEG picture with the quality equal to Standard is created at the same time.
- When the quality is set to [RAW]
 - A JPEG file is also created simultaneously. Its quality is equal to FINE and its size is fixed to ([8M], [7M], [55M]).
 - When the RAW file is deleted on the camera, the created JPEG file is also deleted.
- Pictures may appear like a mosaic depending on the subject or the recording condition.
- The number of recordable pictures depends on the subject.
- The number of remaining pictures displayed on the screen may not correspond with recorded frames.

- The following functions cannot be used for pictures recorded in [TIFF] or [RAW].

- [AUDIO DUB.]
- [RESIZE]
- [TRIMMING]

- The following functions cannot be used when the quality is set to [TIFF] or [RAW].

- Auto bracket
- Burst mode
- [AUDIO REC.]

- Refer to P31 for the number of recordable pictures.

- The software [PHOTOfunSTUDIO-viewer-] or ArcSoft [PhotoImpression] in the CD-ROM (supplied) allows you to develop RAW files and save them as JPEG format pictures.

- For more information about a software application's support for DMC-FZ30 RAW files, refer to the company's home page.
 - Adobe Systems Inc. (Photoshop CS etc.)
 - <http://www.adobe.com>





[REC] mode menu (Refer to P81 for the setting method.)** Audio Recording [AUDIO REC.]**

You can take a picture with audio.

- When you set [AUDIO REC.] to [ON],  appears on the screen.
- When you start recording by focusing on the subject and pressing the shutter button, the audio recording will be automatically stopped in about 5 seconds. There is no need to keep pressing the shutter button.
- Audio is recorded from the built-in microphone of the camera.
- If you press the [MENU] button during the audio recording, the audio recording will be canceled. The audio cannot be recorded.
- You cannot record pictures with audio in burst mode or with the auto bracket when the quality is set to [TIFF] or [RAW] or in [STARRY SKY] (P79) in scene mode.
- When audio is recorded with each picture, the total number of pictures that can be stored on each card will slightly decrease.
- **If you rotate the focus ring or zoom ring, a grinding noise may be recorded.**

 Metering Mode [METERING MODE]



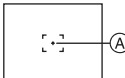





You can switch to the following metering modes.

	Multiple: This is the method in which the camera measures the most suitable exposure by judging the allocation of brightness on the whole screen automatically. Usually, we recommend using this method.
	Center weighted: This is the method used to focus on the subject on the center of the screen and measure the whole screen evenly.
	Spot: This is the method to measure the subject in the spot metering target  . 

[REC] mode menu (Refer to P81 for the setting method.)

[AF] AF Mode [AF MODE]

PASM  **SCN1** **SCN2**

	<p>9-area-focusing: The camera focuses on any of 9 focus areas. You can record a picture in free composition without limiting the position of the subject.</p> 
	<p>3-area-focusing (High speed): The camera focuses on any of the left, center and right of the screen.</p> 
	<p>1-area-focusing (High speed): Adjust the AF area to match the subject.</p> 
	<p>1-area-focusing: Adjust the AF area to match the subject</p> 

<input type="checkbox"/>	<p>Spot-focusing: The camera focuses on the limited and narrow area in the screen.</p> 
--------------------------	--

High speed AF (H) mode

- When you select 3-area-focusing (High speed) or 1-area-focusing (High speed), the auto focus is activated in high speed and you can focus on the subject more quickly.
- When you press the shutter button halfway, a picture may become still for a moment in the condition before being focused. However, it is not a malfunction. If you do not want to make pictures still during the auto focus, use the AF mode other than 3-area-focusing (High speed) mode and 1-area-focusing (High speed) mode.

■ Selecting the AF area

When selecting 1-area-focusing or 1-area-focusing (High speed), the AF area can be selected as shown in the following figure. When using spot-focusing you can also move the spot metering target to match the AF area.

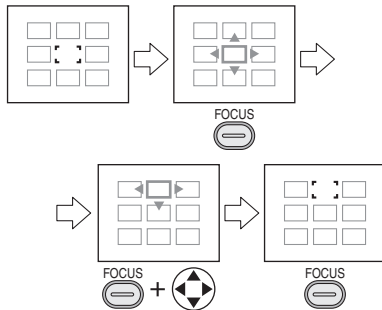

- ❶ Set the Focus switch to [AF] or [AF MACRO].
 - ❷ Press the [FOCUS] button.
 - ❸ While pressing the [FOCUS] button, use ▲/▼/◀/▶ to move the AF area.
 - ❹ Release the [FOCUS] button to set.
- The following operations will return the AF area to the previous one
 - Setting the mode dial to auto mode [A].
 - Turning the camera off.



- When using the digital zoom or when you take pictures in dark places, the AF area is displayed on the center of the screen with a size wider than usual.



- When multiple AF areas (max. 9 areas) light at the same time, the camera is focusing on all the AF areas. The focus position is not predetermined because it is set to the position that the camera automatically determines at the time of focusing. If you want to determine the focus position to take pictures, switch the AF mode to 1-area-focusing mode or Spot-focusing mode.

[REC] mode menu (Refer to P81 for the setting method.)**CAF Continuous AF [CONT.AF]**

This mode allows you to compose a picture more easily by always focusing on the subject.

When the AF mode is set to 1-area-focusing, 1-area-focusing (High speed) or spot-focusing, the time required for focusing when pressing the shutter button halfway will be reduced.

- When it is set to [ON], the [CAF] indication appears.



- The battery may be consumed faster than usual.
- It may take time to focus on the subject after rotating the zoom ring from Wide to Tele or suddenly changing the subject from a distant one to a nearby one.
- Press the shutter button halfway again when it is difficult to focus on the subject.
- In auto mode [A], the [CONT.AF] setting is fixed to [OFF].

AF* AF Assist Lamp [AF ASSIST LAMP]

Illuminating the subject with the AF assist lamp allows the camera to focus on the subject in low light conditions.

When you press the shutter button halfway in dark places or other situations, an AF area wider than usual appears and the AF assist lamp (A) turns on.



ON	The AF assist lamp turns on under low light conditions. In this time, the AF assist lamp icon [AF*] appears on the screen. The effective range of the AF assist lamp is 1.5 m (4.92 feet).
OFF	The AF assist lamp does not turn on.

[REC] mode menu (Refer to P81 for the setting method.)



- Be sure of the following points when the AF assist lamp is in use.
 - Do not look into the AF assist lamp.
 - Detach the lens hood.
 - Do not cover the AF assist lamp with your fingers when taking a picture.
 - The battery may be consumed faster than usual when using the AF assist lamp.
- In auto mode [A], the [AF ASSIST LAMP] setting is fixed to [ON].
- You cannot use the AF assist lamp in [SCENERY] (P73), [NIGHT SCENERY] (P74), [FIREWORKS] (P77) and [PANNING] (P80) in scene mode.
- When you do not want to use the AF assist lamp (e.g. when you take a picture of a subject in a dark place), set the [AF ASSIST LAMP] to [OFF]. In this case, it becomes difficult to focus on the subject.
- The AF area is set only to a point on the center of the screen when the AF assist lamp is turned on.
- A vignetting effect may appear on the circumference of the AF assist lamp because the AF assist lamp may be obscured by the lens, however, this does not cause a problem with the performance of the camera.

Digital Zoom [D.ZOOM]



In the [REC] menu (P81), setting [D.ZOOM] to [2×] or [4×] allows you to magnify a subject up to a maximum of 48 times. (Except when using extended optical zoom.)
Refer to P34 for details.

Color Effect [COL.EFFECT]



You can use 4 types of color effects depending on the atmosphere of the picture.

COOL	The picture becomes bluish.
WARM	The picture becomes reddish.
B/W	The picture becomes black and white.
SEPIA	The picture becomes sepia.

[REC] mode menu (Refer to P81 for the setting method.)

Picture Adjustment [PICT.ADJ.]

P A S M

Use this function according to the recording situation and the atmosphere of the picture.

CONTRAST	HIGH	Increases the difference between the brightness and the darkness in the picture.
	LOW	Decreases the difference between the brightness and the darkness in the picture.
SHARPNESS	HIGH	The picture is sharply defined.
	LOW	The picture is softly focused.
SATURATION	HIGH	The colors in the picture become vivid.
	LOW	The colors in the picture become natural.
NOISE REDUCTION	HIGH	The noise reduction effect is enhanced. The resolution of the picture may be slightly deteriorated.
	LOW	The noise reduction effect is reduced. You can obtain pictures with higher resolution.



- When you take pictures in dark places, noise may become visible. To avoid picture noise, we recommend setting [NOISE REDUCTION] in [PICT.ADJ.] to [HIGH] or setting the items except [NOISE REDUCTION] to [LOW] to take pictures.

Flip Animation [FLIP ANIM.]

P A S M **SCN1** **SCN2**

This camera allows you to create motion picture files up to 20 seconds long by connecting images recorded in flip animation mode.

Example:

When capturing images of the subject in sequence moving the camera little by little and aligning the images, the subject looks as if it is moving.

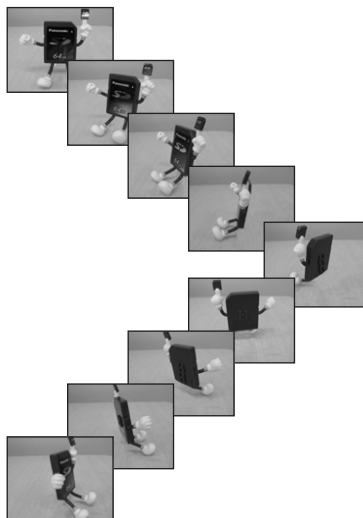

- You can play back created flip animations with the same method used to play back motion pictures. (P100)

1 Select [FLIP ANIM.].

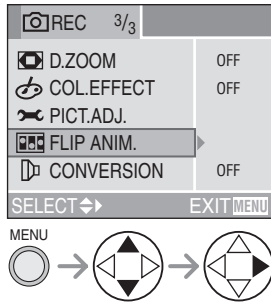

2 Select [PICTURE CAPTURE].

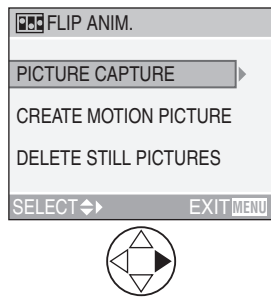

- The picture size is 320×240 pixels.

3 Capture images for flip animation.

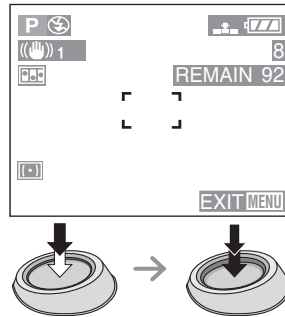

- You can check the recorded image with and the previous or following image with .
- Delete unnecessary images with button.
- You can record up to 100 pictures. The number of recordable pictures displayed is an approximation.

4 Select [CREATE MOTION PICTURE].

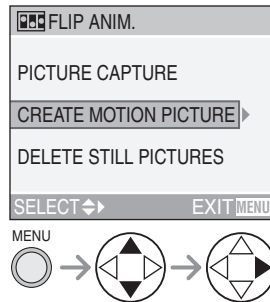

5 Select [FRAME RATE] and set the number of frames.

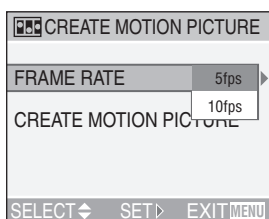

5fps	5 frames/sec.
10fps	10 frames/sec. (The motion pictures become smoother.)

6 Select [CREATE MOTION PICTURE] and create a flip animation.

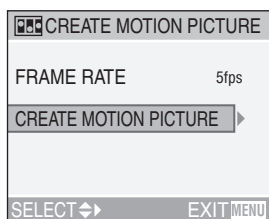

3 times

- The file number appears after creating a flip animation.

Deleting all still images used to create flip animation

When selecting [DELETE STILL PICTURES] in [FLIP ANIM.] menu, a confirmation screen appears. Select [YES] with ▼ and then press ►.



- You cannot use the direction detection function, burst mode, auto bracket and [AUDIO REC.].
- The images in each frame do not appear in normal review. (P44)
- If you execute [CREATE MOTION PICTURE], flip animation is made from all pictures recorded for flip animation. Delete unnecessary pictures.
- Audio cannot be recorded.
- You cannot record audio using the audio dubbing. (P109)
- Play back may not be possible on other equipment. You may also hear noise during play back on other equipment which does not have a mute function.

[REC] mode menu (Refer to P81 for the setting method.)

Conversion Lens [CONVERSION]



The tele conversion lens (DMW-LT55; optional) allows you to record pictures zooming in much more (1.7 times). The wide conversion lens (DMW-LW55; optional) allows you to record pictures with wider range of focus than usual (0.7 times).

1 Remove the lens cap and attach the tele conversion lens ① or wide conversion lens ②.

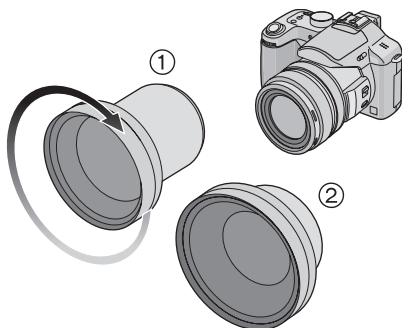

- Conversion lens cannot be used together with the ND filter (DMW-LND55) and the MC protector (DMW-LMC55). Always detach the ND filter or MC protector before attaching the conversion lens.
- Rotate the lens slowly and carefully.

2 Turn the camera on and select [CONVERSION].

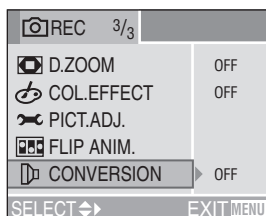

3 Set to [] or [].

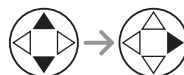
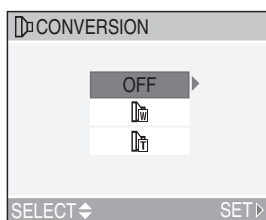

- [OFF]: When you do not attach the conversion lens.
- []: When you attach the wide conversion lens.
- []: When you attach the tele conversion lens.
- Close the menu by pressing the shutter button halfway or the [MENU] button after finishing the setting.

4 Set to Tele or Wide.

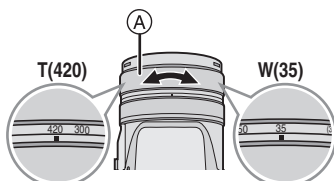

A: Zoom ring

- Always set to Tele when using a tele conversion lens and to Wide when using a wide conversion lens.
- The conversion icon ([] or []) changes from red (blinking) to white.
- When using a conversion lens, ensure the conversion icon is white when taking pictures. If pictures are taken when it is blinking, performance will not be up to specification.

■ Recordable range when using the conversion lens

Tele conversion lens	
Indication	12×
Actual magnification	20.4×
35 mm film camera equivalent	714 mm

Wide conversion lens	
Indication	1×
Actual magnification	0.7×
35 mm film camera equivalent	24.5 mm

*The actual magnification when using digital zoom (P34) and extended optical zoom (P34) is 1.7× that of the Tele display.

- Focus range is from 14 cm (0.46 feet) to ∞ (wide conversion lens) and from 5.5 m (18.0 feet) to ∞ (tele conversion lens).



- Digital zoom cannot be used when using a wide conversion lens.
- When there is dirt (water, oil, and fingerprints, etc.) on the surface of the lens, the image may be affected. Lightly wipe the surface of the lens with a soft, dry cloth before and after taking pictures.
- Ensure that [CONVERSION] is set to [OFF] when not using a conversion lens.
- When using the conversion lens:
 - The built-in flash cannot be activated.
 - If you set [CONVERSION] to [OFF], the performance of the conversion lens will not be optimal.
- When using the tele conversion lens:
 - We recommend using a tripod.
 - The stabilizer function may not work sufficiently.
 - The focus indication may light due to the jitter even if the subject is not focused.
 - The time required for focusing may become longer than usual.
- If you use an extra flash when a conversion lens is attached, we recommend setting the extra flash to manual mode. Refer to the operating instructions of the extra flash for details.
- If you set [CONVERSION] to [] or [], you cannot use the AF assist lamp. (P90)
- Read the operating instructions of the conversion lens for details.

[REC] mode menu (Refer to P81 for the setting method.)

Extra Flash [EXT.FLASH]



After installing the extra flash (DMW-FL28; optional), the effective range will be increased when compared to the camera's built in flash.

1 Attach the extra flash to the hot shoe (A) and turn the camera and the extra flash on.

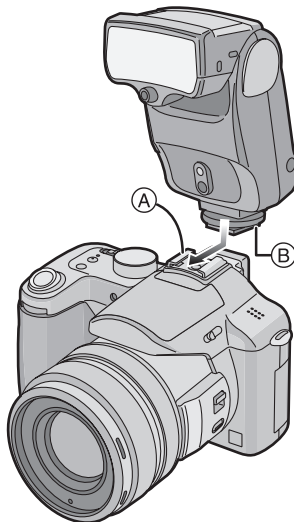

- Tighten the lock screw (B) of the extra flash firmly.

2 Select [PRESET] or [MANUAL].

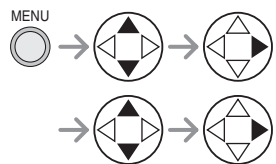
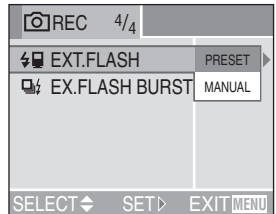

- Close the menu by pressing the shutter button halfway or the [MENU] button after finishing the setting.

Switch the extra flash forced off setting

Press ► to switch the setting.

Icon	Setting
	Extra flash Forced ON
	Extra flash Forced OFF

[REC] mode menu (Refer to P81 for the setting method.)**■ Settings on the extra flash**

• [PRESET]

– When setting to [PRESET] and attaching the extra flash, the aperture value and the ISO sensitivity are respectively set to [F4] and [ISO100] on the camera regardless of the recording mode. Set the extra flash to [AUTO] and set the same value as the settings on the camera.

– We recommend setting to [PRESET] for normal use.

• [MANUAL]

– When setting to [MANUAL], you can set the aperture value, the shutter speed and the ISO sensitivity on the camera even if the extra flash is attached.

– When setting to [MANUAL], set to the Aperture-priority AE or the Manual exposure on the camera and then set the same aperture value and the ISO sensitivity on the extra flash. (The extra flash cannot control the light adequately due to the change in aperture value on Shutter-priority AE and Program AE.)

normal mode, 1 to 1/250th in [NIGHT PORTRAIT] (P74) in scene mode.

• **Even if the extra flash is turned off, the camera may enter flash mode when the extra flash is attached. When you are not using the extra flash, detach it or set it to Forced OFF.**

• When attaching the extra flash, the built-in flash cannot be activated.

• Do not open the built-in flash when an extra flash is attached.

• When attaching the extra flash, the camera will become unstable.

• Detach the extra flash when carrying the camera.

• When attaching the extra flash, do not hold only the extra flash because it may detach from the camera.

• If you use the extra flash when the white balance is set to [Flash] (Flash) finely adjust the white balance depending on the picture quality. (P82)

• If you take pictures close to the subject in Wide, a vignetting effect may appear on the bottom of the recorded picture.

• Read the operating instructions of the extra flash for details.



• Some commercial extra flashes have synchro terminals with high-voltage or reversed polarity.

Using such extra flashes may cause a malfunction or the camera may not operate normally.

Be sure to use Panasonic's extra flash (DMW-FL28).

• If using other extra flash units, please make sure the flash is designed for use with a digital camera and the trigger voltage is based on ISO 10330 (less than 24 volts).

• The available flash range is about 10 m (32.8 feet) in DMW-FL28. (When setting to [ISO100])

• When attaching the extra flash, the shutter speed becomes 1/30th to 1/250th in

[REC] mode menu (Refer to P81 for the setting method.)



This mode allows you to take multiple pictures at one time when the extra flash is attached.

- Set [EX.FLASH BURST] to [ON].
- Press the Single/Burst Mode Button to switch the burst mode setting.
- You can take up to 3 pictures by keeping the shutter button pressed down.

■ Number of pictures recorded in burst mode

	Burst speed (pictures/second)	Number of recordable pictures (pictures)
	3	max. 3
	2	
	Approx. 2	



- Depending on the extra flash you use or the recording conditions, you cannot take pictures in this mode or the amount of light may become insufficient for the second or subsequent pictures.

Playing Back Pictures with Audio/Motion Pictures





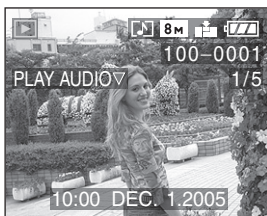

■ Pictures with audio





Select the picture with audio icon [] and play back the audio.





■ Motion pictures

Select the picture with the motion picture icon [] / [] / [] / [] and play back the motion pictures.



- The cursor displayed during playback corresponds to  /  /  / .
- Motion picture playback stops and the normal playback is restored by pressing .

Fast forwarding/Fast rewinding

During motion picture playback, keep pressing  / .

 : Fast forward

 : Fast rewind

- When releasing the button, it turns to normal motion picture playback.

To pause

Press  during motion picture playback.

- Press  again to cancel pause.



- Sound can be heard through the speaker. Refer to [VOLUME] (P23) for information about how to adjust the volume on the [SETUP] menu.

- Pictures with audio and motion images cannot be resized (P110) or trimmed (P111).
- You cannot use the zoom function while playing back or pausing motion pictures.
- The file format that can be played back with the camera is QuickTime Motion JPEG.
- Some QuickTime Motion JPEG files recorded by a PC or other equipment may not be played back with the camera.
- When playing back motion pictures that have been recorded with other equipment, the quality of images may be deteriorated or it may not be possible to play them back.
- When using a high capacity card, it is possible that fast rewinding may be slower than usual.
- When playing back pictures recorded with this unit on a PC, use the software [QuickTime] in the CD-ROM (supplied).

Using the [PLAY] mode menu



You can use various functions in playback mode such as a rotating function or protections for recorded pictures.

Menu items

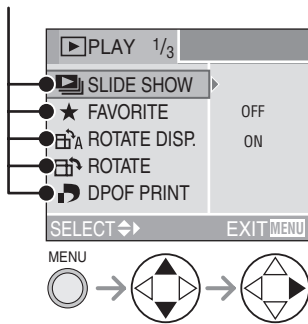

- Rotate the front dial to switch between pages 1/3, 2/3, and 3/3.
- After selecting a menu item with the operation described above, make settings for each menu.

: [SLIDE SHOW] (P102)

: [FAVORITE] (P103)

: [ROTATE DISP.] (P104)

: [ROTATE] (P105)

: [DPOF PRINT] (P106)

: [PROTECT] (P108)

: [AUDIO DUB.] (P109)

: [RESIZE] (P110)

: [TRIMMING] (P111)

: [ASPECT CONV.] (P113)

: [CLEAN UP] (P114)

: [FORMAT] (P115)

[PLAY] mode menu (Refer to P101 for how to select the menu.)

Playing Back with Slide Show
[SLIDE SHOW]

1 Select [ALL] or [★].

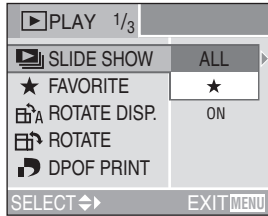

ALL	Displays all pictures.
★	Displays only those pictures that have been set as favorites (P103).

- [★] appears when [FAVORITE] is set to [ON]. When it is set to [OFF], perform step 2.
- However, if none of the pictures have [★] displayed, you cannot select [★] even if [FAVORITE] is set to [ON].

2 Set the items of the Slide Show.

(Screen when [ALL] is selected)

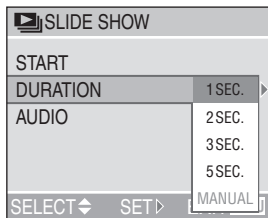

DURATION	Can be set at [1SEC.], [2SEC.], [3SEC.], [5SEC.] or [MANUAL] (manual playback).
AUDIO	By setting it to [ON], the audio of the pictures with audio can be played back during Slide Show.

- You can select [MANUAL] only when [★] has been selected in step 1.

3 Select [START].

(Screen when [ALL] is selected)

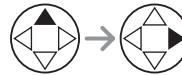
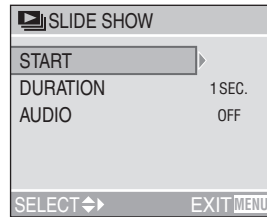

- When [MANUAL] is selected, press ◀▶ and confirm the previous and following pictures.

4 By pressing the [MENU] button, the Slide Show stops.



- Motion pictures cannot be played back in the Slide Show.
- When you play back pictures with audio, the next picture appears after the playback of the audio is finished (when [AUDIO] is set to [ON]).

[PLAY] mode menu (Refer to P101 for how to select the menu.)

★ Setting Favorites [FAVORITE]

You can add a mark [★] (favorites icon) to your favorites images. After you set images as favorites, you can then delete the images not set as favorites ([ALL DELETE EXCEPT ★]) (P62) and play back the images set as favorites only as a Slide Show (P102). Before going to a photo studio for digital printing, using [ALL DELETE EXCEPT ★] is convenient so only the pictures you want the photo studio to print remain on the card.

1 Select [ON] to set it.

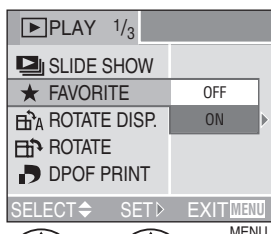

- You cannot set favorites if [FAVORITE] is set to [OFF]. Also [★] favorites icon will not appear when [FAVORITE] is set to [OFF] even if [FAVORITE] was previously set to [ON].

2 Select the picture and set it.



- Repeat the above procedure.
- If ▲ is pressed while the [★] favorites icon (A) is displayed, [★] is cleared, and the favorites setting is canceled.
- You can set up to 999 images as favorites.



- Using [LUMIX Simple Viewer] or [PHOTOfunSTUDIO-viewer-] (for Windows®) on the CD-ROM (supplied), favorites can be set, confirmed or deleted. (For details please refer to the separate operating instructions for PC connection.)
- Images taken with different equipment may not be able to be set as favorites.

[PLAY] mode menu (Refer to P101 for how to select the menu.)

Displaying pictures in a direction at the time of recording [ROTATE DISP.]

This mode allows you to display pictures recorded by holding the camera vertically or pictures rotated in [ROTATE] function in the rotated direction.

1 Select [ON] to set it.

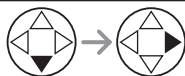
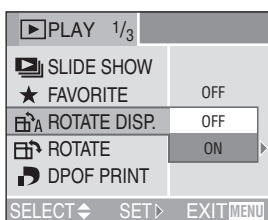

- When you select [OFF], the pictures are displayed without being rotated.
- Refer to P59 for how to play back pictures.



- When you take pictures by holding the camera vertically, read “Tips for taking good pictures” on P28 carefully.
- The direction detection function (P28) may not work properly on pictures recorded by aiming the camera up or down.
- When playing back rotated pictures in multi playback, pictures appear in original orientation.
- You can rotate and display pictures by using the [ROTATE] function even if you do not take pictures by holding the camera vertically.
- When you connect the camera to a TV and play back a picture vertically, it may be blurry. [When using the AV cable (supplied)]

[PLAY] mode menu (Refer to P101 for how to select the menu.)

Rotating the Picture [ROTATE]

You can rotate the recorded pictures in steps of 90° and display them.

Example

When rotating clockwise (↻)

Original picture

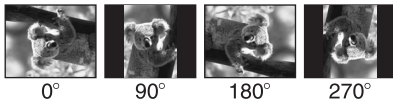

1 Select the picture to be rotated and set it.

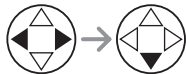
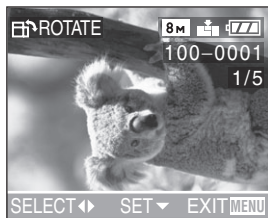

- The following pictures cannot be rotated.
 - Motion pictures
 - Protected pictures

2 Select the direction to rotate the picture.

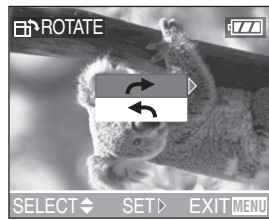

2 times

↻	The picture rotates clockwise in steps of 90°.
↺	The picture rotates counter-clockwise in steps of 90°.



- When you play back pictures on a PC, you cannot play back pictures keeping the rotated direction without an OS or software compatible with Exif.
- Exif is the file format for still pictures, to which recording information and other detail can be added to the picture, established by JEITA [Japan Electronics and Information Technology Industries Association].
- When [ROTATE DISP.] is set to [OFF], [ROTATE] function is disabled.
- When pictures are recorded by holding the camera vertically, the pictures are played back vertically (the pictures are rotated).
- It may not be possible to rotate pictures that have been recorded with other equipment.

[PLAY] mode menu (Refer to P101 for how to select the menu.)

Setting the Picture to be Printed and the Number of Prints [DPOF PRINT]

DPOF (Digital Print Order Format) is a system that allows the user to select which pictures are to be printed, how many copies of each picture will be printed or whether the recording date is to be printed on compatible photo printers or commercial photo printing services.

For details, ask photo printing servicer.
For more information please visit:
http://panasonic.jp/dc/dpof_110/white_e.htm

1 Select [SINGLE], [MULTI] or [CANCEL].

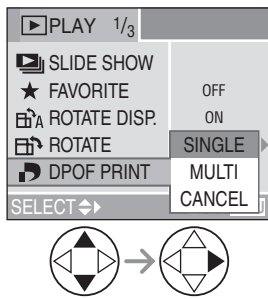

Single setting

Select the picture and set the number of prints.

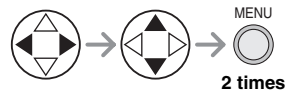

- The number of prints can be set from 0 to 999.
- The number of prints icon [DPOF] appears.
- When the number of prints is set to "0", DPOF print setting is canceled.

Multi setting

Select the pictures and set the number of prints.

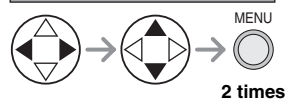
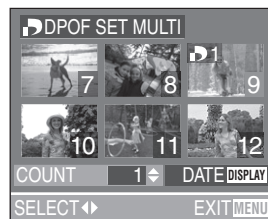

- Repeat the above procedure.
- The number of prints can be set from 0 to 999.
- The number of prints icon [DPOF] appears.
- When the number of prints is set to "0", DPOF print setting is canceled.

■ **To cancel all settings**
Select [YES] to cancel all settings.

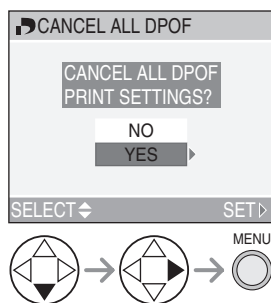

■ **To print the date**

You can set/cancel the printing with the recorded date by pressing the [DISPLAY] button after setting the number of prints.



- The date print icon [DATE] appears.
- When using the software [LUMIX Simple Viewer] or [PHOTOfunSTUDIO-viewer-] in the CD-ROM (supplied), you can print pictures with the date by setting the date print on the print settings. For details, refer to the separate operating instructions for PC connection.
- When you go to a photo studio for digital printing, be sure to order the printing of the date additionally if required.
- The date may not be printed depending on photo studios or printers even if you set the date print. For further information, ask the photo studio or refer to the operating instructions of the printer.



- DPOF print setting is a convenient function when you print pictures with printers supporting PictBridge. (P121)
- DPOF is an abbreviation of Digital Print Order Format. This feature allows you to write print information into the media and to use such information on the DPOF-compliant system.
- If the file is not based on the DCF standard, the DPOF print setting cannot be set. DCF is an abbreviation of [Design rule for Camera File system], stipulated by JEITA [Japan Electronics and Information Technology Industries Association].
- When setting the DPOF print on the camera, delete any previous DPOF print settings made by other equipment.

[PLAY] mode menu (Refer to P101 for how to select the menu.)

Preventing Accidental Erasure of the Picture [PROTECT]

You can set the protection for the pictures which you do not want to be deleted by accident.

1 Select [SINGLE], [MULTI] or [CANCEL].

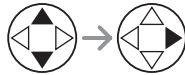
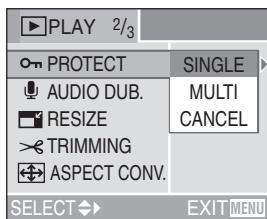

Single setting
Select the picture and set/cancel the protection.



2 times

SET	The protect icon [] appears.
CANCEL	The protect icon [] disappears.

Multi setting/To cancel all settings

Perform the same operation as in “Setting the Picture to be Printed and the Number of Prints [DPOF PRINT]”. (P106–107)



- If you want to delete protected pictures, cancel the protect setting first.
- While this feature protects the pictures from accidental erasure, formatting the card will permanently delete all data. (P115)
- The protect setting may not be effective in other equipment.
- Sliding the Card Write-Protect switch (A) on the SD Memory Card to [LOCK] prevents the picture from deletion even if the protection is not set.

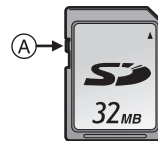

- The following functions cannot be used with protected pictures.
 - [ROTATE] (P105)
 - [AUDIO DUB.] (P109)

[PLAY] mode menu (Refer to P101 for how to select the menu.)

Adding Audio to Recorded Pictures [AUDIO DUB.]

You can record the audio after taking a picture (max. 10 seconds per picture).

1 Select the picture and start audio recording.

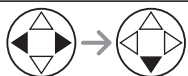

- When audio has already been recorded, the confirmation screen appears. Press **▼** to select [YES], and press **▶** to start audio recording. (The original audio is overwritten.)
- The audio dubbing cannot be used with the following pictures.
 - Motion pictures
 - Protected pictures
 - Pictures recorded after setting the quality to [TIFF] or [RAW]
- The audio dubbing may not work properly on pictures recorded by other equipment.

2 Stop audio recording.



2 times

- The audio recording stops by pressing the **▼** button.
- Even if you do not press **▼**, after about 10 seconds, the audio recording stops automatically.



- **While dubbing, if the focus ring or zoom ring are turned, the sound of rubbing with the lens barrel may be recorded.**

[PLAY] mode menu (Refer to P101 for how to select the menu.)

Resizing the Pictures [RESIZE]

This function is useful if you want to reduce the file size of the picture in cases when it needs to be attached to an e-mail or uploaded to a website.

1 Select the picture and set it.

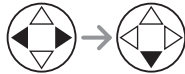
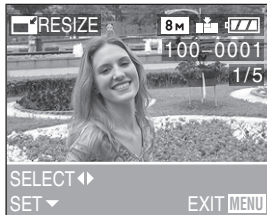

- The following pictures cannot be resized.
 - When the aspect ratio setting is [4:3].
 - Pictures recorded in [0.3M] (0.3M EZ)
 - When the aspect ratio setting is [3:2].
 - Pictures recorded in [2.5M] (2.5M EZ)
 - When the aspect ratio setting is [16:9].
 - Pictures recorded in [2M] (2M EZ)
 - Pictures recorded after setting the quality to [TIFF] or [RAW]
 - Motion pictures
 - Flip animation
 - Pictures with audio
- It may not be possible to resize pictures recorded with other equipment.

2 Select the size and set it.



- Sizes smaller than the recorded picture are displayed.
 - When the aspect ratio setting is [4:3].
 - [5M], [3M], [2M], [1M], [0.3M]
 - When the aspect ratio setting is [3:2].
 - [4.5M], [2.5M]
 - When the aspect ratio setting is [16:9].
 - [2M]

[PLAY] mode menu (Refer to P101 for how to select the menu.)

3 Select [YES] or [NO] and set it.

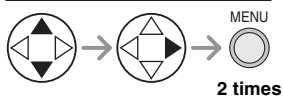

- When you select [YES], the picture is overwritten. When resized pictures are overwritten, they cannot be restored.
- When the original picture is protected, you cannot overwrite the resized picture.
- When you select [NO], a resized picture is newly created.

> Trimming the Pictures [TRIMMING]

Use this function when you trim needed parts of the recorded picture.

1 Select the picture to trim and set it.

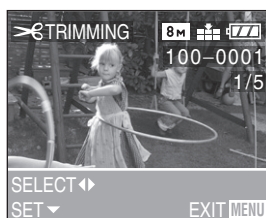

- The following pictures cannot be trimmed.
 - Pictures recorded after setting the quality to [TIFF] or [RAW]
 - Motion pictures
 - Flip animation
 - Pictures with audio
- It may not be possible to trim pictures recorded with other equipment.

2 Enlarge or decrease the picture.

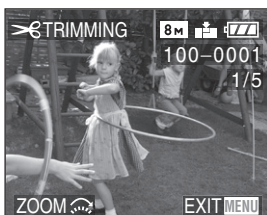

3 Shift the picture and press the shutter button to set.

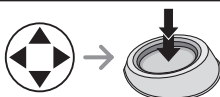
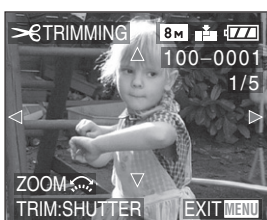

4 Select [YES] or [NO] and set it.

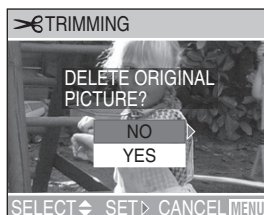

2 times

- When you select [YES], the picture is overwritten. When trimmed pictures are overwritten, they cannot be restored.
- When the original picture is protected, you cannot overwrite the trimmed picture.
- When you select [NO], a trimmed picture is newly created.



- The picture size of the trimmed pictures may become smaller than that of the original one depending on the cut size.
- The picture quality of the trimmed picture will be deteriorated.

[PLAY] mode menu (Refer to P101 for how to select the menu.)

Aspect ratio conversion
[ASPECT CONV.]

Images taken using [16:9] aspect can be converted to [3:2] or [4:3] for printing.

1 Select [3:2] or [4:3].

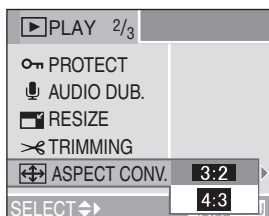

• Only pictures taken using [16:9] aspect can be converted.

2 Select the picture to convert and set it.

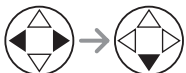

• Selecting and setting pictures with aspects other than [16:9] will display [CANNOT BE SET ON THIS PICTURE].

3 Determine the horizontal position and set with the shutter button.

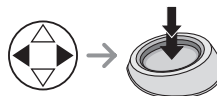

• For pictures rotated vertically use ▲/▼ to set the frame position.

4 Select [YES] or [NO] and set it.

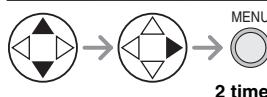

2 times

• When the original picture is protected, you cannot overwrite it.

[PLAY] mode menu (Refer to P101 for how to select the menu.)



- The following pictures cannot be converted.
 - Pictures with audio
 - Motion pictures
 - Pictures recorded after setting the quality to [TIFF] or [RAW]
- You may not be able to convert pictures taken on other equipment.
- Files not conforming to the DCF standard cannot be converted. DCF is an abbreviation of [Design rule for Camera File system], stipulated by JEITA [Japan Electronics and Information Technology Industries Association].



Clean-up [CLEAN UP]

[CLEAN UP] recovers the data writing speed, which has been reduced, of the SD memory card.

In general, the data writing speed of the SD memory card reduces when recording and deletion are repeated. In this case, recording may stop in the middle while you are recording motion pictures. We recommend you to clean up the card using the camera before recording motion pictures.

1 Select [YES] to start the clean-up.

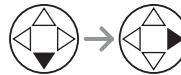
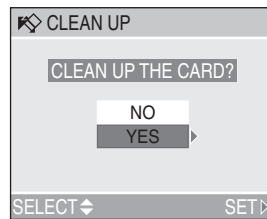

[PLAY] mode menu (Refer to P101 for how to select the menu.)



- [CLEAN UP] is a function to recover the speed of writing into a free space in the card. Therefore, pictures and data already recorded in the card will not be erased.
- When you start clean-up, it may take time to complete.
- Depending on the type of card, [CLEAN UP] may not be effective.
- [CLEAN UP] does not support MultiMediaCard.
- During clean-up do not turn the camera off.
- When you clean up the card, use a battery with sufficient battery power (P13) or AC adaptor (DMW-CAC1; optional).
- When the SD Memory Card Write-Protect switch is slid to [LOCK], you cannot clean up the card.



Initializing the Card [FORMAT]

1 Select [YES] to format.

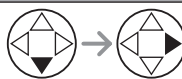
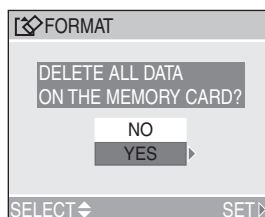

- Usually, it is not necessary to format the card. Format it when the message [MEMORY CARD ERROR] appears.
- If the card has been formatted by a PC or other equipment, format it on the camera again.
- **Once the card is formatted, all data including protected images are irretrievably erased. Please confirm that all data is transferred to your PC before proceeding with format function.**
- During formatting, do not turn the camera off.
- When you format the card, use a battery with sufficient battery power (P13) or AC adaptor (DMW-CAC1; optional).
- When the SD Memory Card Write-Protect switch is slid to [LOCK], you cannot format the card.
- If the card cannot be formatted, consult your nearest servicenter.

For USA assistance, please call: 1-800-272-7033
or send e-mail to : digitalstillcam@panasonic.com

For Canadian assistance, please call:
1-800-561-5505 or visit us at www.panasonic.ca

Playing Back Pictures on a TV Screen

■ Playing back pictures with AV cable (supplied)

- Turn the camera and the TV off.

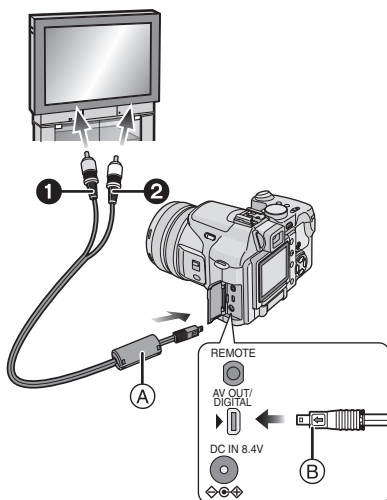

1 Connect the AV cable (A) (supplied) to the [AV OUT] socket of the camera.

- Connect the AV cable with the [➡] mark facing the [▶] mark on the [AV OUT] socket.
- Hold the AV cable at (B) and insert straight in and take straight out.

2 Connect the AV cable to the video input and the audio input sockets of the TV.

- ① Yellow: to the video input socket
- ② White: to the audio input socket

3 Turn the TV on and select external input.

4 Turn the camera on and then set the mode dial to playback mode [▶].

■ Viewing pictures in other countries

When setting [VIDEO OUT] on the [SETUP] menu, you can view images on the TV in other countries (regions) which use the NTSC or PAL system.

- Even if you set menu selection for [VIDEO OUT] to [PAL], the output signal is still NTSC in the recording mode.

■ Playback pictures on TV with SD Memory Card slot

Still pictures recorded to an SD Memory Card can be played back on TVs with an SD Memory Card slot.

(Pictures may not be displayed on a full screen, depending on the model of TV. MultiMediaCard may not be played back on TV with SD Memory Card slot.)

- Motion pictures cannot be played back. To play back motion pictures, connect the camera to a TV with the AV cable (supplied).



- Do not use any other AV cables except the supplied one.
- Read the TV operating instructions too.
- Audio playback is in monaural.
- When you connect the camera to a TV and play back a picture vertically, it may be blurry. (When using the AV cable)
- When you connect the camera to a TV and play back a picture, you may not be able to see one part of the edges of the screen. This is due to the specifications of the TV and is not a malfunction.

Before Connecting to the PC or the Printer

[**USB**] : **USB MODE**]

Select the USB communication system before connecting the camera to your PC or your printer with the USB connection cable (supplied).

Set the items on [USB MODE] in the [SETUP] menu. (P24)



- When [PC] is selected, the camera is connected via USB Mass Storage communication system.
- When [PictBridge (PTP)] is selected, the camera is connected via PTP (Picture Transfer Protocol) communication system.

1 Select [**USB MODE**].

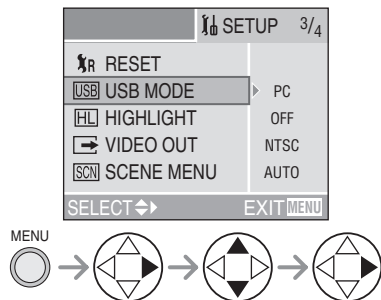

2 Select [**PC**] or [**PictBridge (PTP)**].

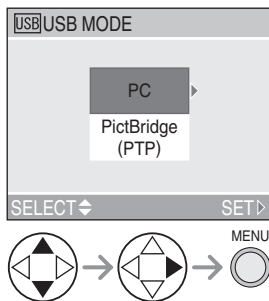

- If you connect the camera to a PC, select [PC]. (P118)
- If you connect the camera to a printer supporting PictBridge, select [PictBridge (PTP)]. (P121)

Connecting to a PC

You can load pictures recorded with the camera to a PC by connecting the camera and PC.

The software [LUMIX Simple Viewer] or [PHOTOfunSTUDIO-viewer-] (for Windows®) in the CD-ROM (supplied) allows you to load pictures recorded with the camera to a PC, print, or send them by e-mail easily.

If you use Windows 98/98SE, install the USB driver and then connect it to the computer.

Refer to the operating instructions for PC connection for detailed information about the software included in the CD-ROM (supplied) and installation.

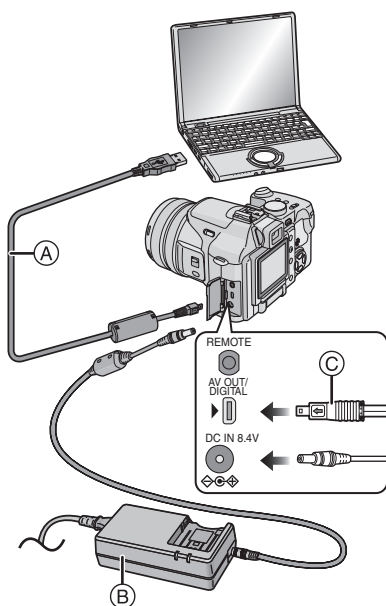

- (A): USB connection cable (supplied)
 (B): AC adaptor (DMW-CAC1; optional)
- Turn off the camera before inserting or removing the cable for the AC adaptor (DMW-CAC1; optional).

1 Turn the camera on and then set [USB MODE] on the [SETUP] menu to [PC]. (P117)

- If you set [USB MODE] to [PictBridge (PTP)] and then connect the camera to the PC, messages may appear on the screen of the PC. Select [Cancel] to close the indications and disconnect the camera from the PC. Connect the camera after you set [USB MODE] again.

2 Connect the camera to a PC via the USB connection cable (A) (supplied).

- Connect the USB connection cable with the [➡] mark facing the [▶] mark on the [DIGITAL] socket.
- Hold the USB connection cable at (C) and insert straight in and take straight out. (Forcibly inserting at a slant or upside down can deform the pins, and this can damage the camera or other connected equipment.)

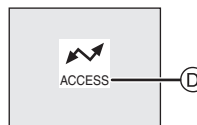

- (D): This message appears during data transfer.

[Windows]

The drive appears on the [My Computer] folder.

- If it is the first time you are connecting the camera to a PC, the required driver is installed automatically so that the camera can be recognized by the Windows Plug and Play, then it appears on the [My Computer] folder.

[Macintosh]

The drive is displayed on the screen as [NO_NAME] or [Untitled].

■ **Folder Composition**

The folder structure of the card or MultiMediaCard is displayed as the illustration below.

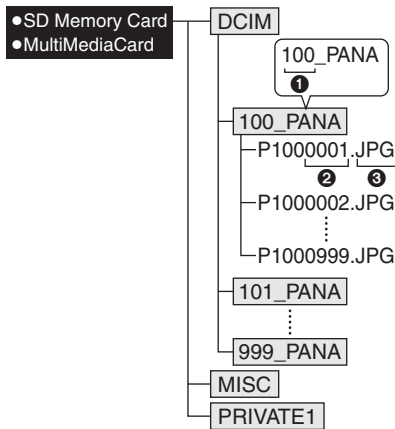

- ❶ Folder number
- ❷ File number
- ❸ JPG: pictures
MOV: motion pictures

Files will be saved in each folder as follows.

DCIM	Folders from [100_PANA] to [999_PANA]
100_PANA	Pictures/motion pictures
MISC	Files on which the DPOF print settings are recorded
PRIVATE1	Pictures recorded in flip animation function

- Image data of up to 999 pictures recorded by the camera can be included in 1 folder. If the number of picture data exceeds 999, another folder will be created.
- When you reset the file number or the folder number, select [NO.RESET] in the [SETUP] menu. (P23)

■ **Conditions under which a different folder number is used**

When recording under the following conditions, new picture files will be recorded to a folder with a different number than the pictures recorded immediately before.

- 1 When the folder just recorded to contains a picture file with the number 999 in it (example:P1000999.JPG).
- 2 When the card just recorded to contains a folder with the number 100 in it (example:100_PANA) and that card is removed and replaced with a card that has a folder with the number 100 in it recorded by a different maker's camera (example:100_XXXXX, with XXXXX being the maker name) and recording is commenced. (When a card is inserted that contains a folder with the same number, regardless of the maker)
- 3 When recording after selecting [No. Reset] from the [SETUP] menu. (Pictures will be recorded to a new folder with a number sequential to the folder recorded to immediately before. By using [No. Reset] on a card that does not contain folders or pictures, such as one just formatted, the folder number can be reset to 100.)



- If the remaining battery power is exhausted during communication, the recorded data may be damaged. When you connect the camera to the PC, use a battery with sufficient battery power (P13) or the AC adaptor (DMW-CAC1; optional).
- If the remaining battery power becomes low during communication, the power indicator blinks (P13) and the alarm beeps. In this case, stop the communication at once.
- While [ACCESS] is being displayed, do not disconnect the USB connection cable.
- **When the OS of your PC is Windows 2000 and you connect the camera to the PC with the USB connection cable, do not replace the card with the camera connected to the PC. The information in the card may be damaged. Make sure to disconnect the USB connection cable beforehand when you replace the card. For details, refer to the separate operating instructions for PC connection.**
- Do not use any other USB connection cables except the supplied one.
- Also refer to the operating instructions of the PC.

■ PictBridge (PTP) setting

Even if you set the [USB MODE] to [PictBridge (PTP)], you can connect to the PC only when the OS is Windows XP Home Edition, Windows XP Professional or Mac OS X.

- You can only load pictures from the camera and cannot write them on the card or delete them.
- When there are 1000 or more pictures on a card, the pictures may not be imported.

Connecting to a PictBridge-compliant Printer

By connecting the camera directly to a printer supporting PictBridge via the USB connection cable (supplied), you can select the pictures to be printed or start printing on the LCD monitor.

Set the print settings such as print quality on the printer beforehand. (Read the printer operating instructions.)

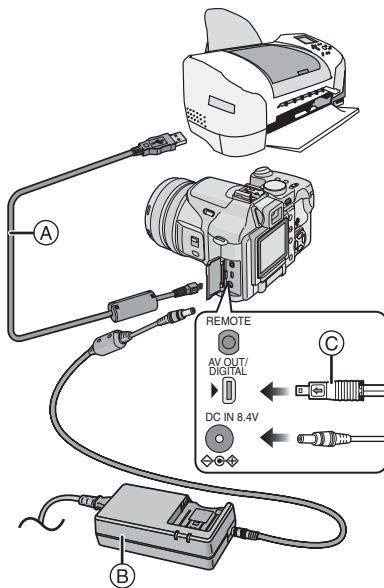

- (A): USB connection cable (supplied)
 (B): AC adaptor (DMW-CAC1; optional)
- Turn off the camera before inserting or removing the cable for the AC adaptor (DMW-CAC1; optional).

1 Turn the camera on and then set [USB MODE] on the [SETUP] menu to [PictBridge (PTP)]. (P117)

2 Turn on the printer.

3 Connect the camera to a printer via the USB connection cable (A) (supplied).

- Connect the USB connection cable with the [➡] mark facing the [▶] mark on the [DIGITAL] socket.
- Hold the USB connection cable at (C) and insert straight in and take straight out.

When the DPOF Print is not set.	Select [SINGLE PICTURE]. (P122)
When the DPOF Print is set.	Select [DPOF PICTURE]. (P123) (P106)



- It may take time to print some pictures. Therefore, use a battery with sufficient battery power (P13) or the AC adaptor (DMW-CAC1; optional) when you connect to a printer.
- If the remaining battery power becomes low during communication, the power indicator blinks and the alarm beeps. In this case, stop the communication at once.
- Disconnect the USB connection cable after printing.
- Do not use any other USB connection cables except the supplied one.
- For printing the age in [BABY] (P75) in the scene mode, print from a PC using the software [LUMIX Simple Viewer] or [PHOTOfunSTUDIO-viewer-] in the CD-ROM (supplied). For details, refer to the separate operating instructions for PC connection.
- To find out more PictBridge compliant printers, please contact your local dealer.

■ Single picture

1 Select a picture to be printed.

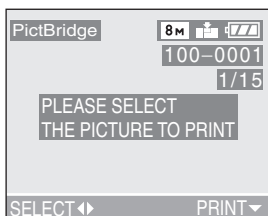

- A message disappears in about 2 seconds.

2 Set the print settings.

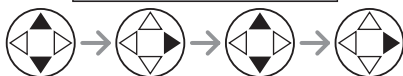
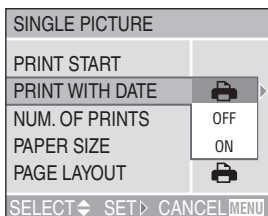

- The items which are not supported by the printer are displayed in gray and cannot be selected.
- When you want to print pictures in a paper size or a layout which is not supported by the camera, set [PAPER SIZE] or [PAGE LAYOUT] to [Printer icon] and then set the paper size or the layout on the printer. (For details, refer to the operating instructions of the printer.)

• [PRINT WITH DATE]

	Settings on the printer are prioritized.
OFF	Date is not printed.
ON	Date is printed.

- If the printer does not support date printing, the date cannot be printed on the picture.

• [NUM. OF PRINTS]

Set the number of prints.

• [PAPER SIZE]

(Possible paper sizes on the camera)

The items are listed on 1/2 and 2/2. Press

▼ to select the desired item.

1/2	
	Settings on the printer are prioritized.
L/3.5"×5"	89 mm×127 mm
2L/5"×7"	127 mm×178 mm
POSTCARD	100 mm×148 mm
A4	210 mm×297 mm
2/2*	
CARD SIZE	54 mm×85.6 mm
10×15cm	100 mm×150 mm
4"×6"	101.6 mm×152.4 mm
8"×10"	203.2 mm×254 mm
LETTER	216 mm×279.4 mm

*These items cannot be displayed when the printer does not support the paper sizes.

• **[PAGE LAYOUT]**

(Possible layouts on the camera)

	Settings on the printer are prioritized.
	1 page with no frame print
	1 page with frame print
	2 pages print
	4 pages print

3 Select [PRINT START] and then print out the picture.

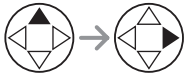
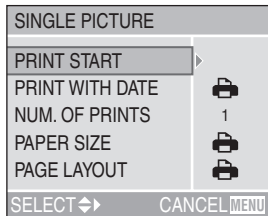

- Press the [MENU] button to cancel printing.

■ **DPOF picture**

- Set the DPOF print with the camera in advance. (P106)

1 Select [DPOF PICTURE].

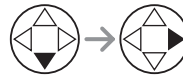
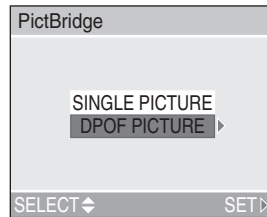

- When printing under the new settings, disconnect the USB connection cable and connect it to the printer again.
- You can change the DPOF print setting by pressing the [MENU] button. (P106)

2 Select [PRINT START] and then print out the picture.

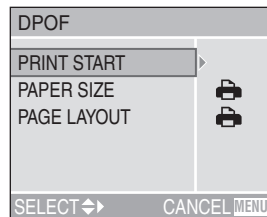

- Refer to P122 for print setting.
- Press the [MENU] button to cancel printing.

■ Setting the date printing with the DPOF print in advance

When the printer supports the date printing by DPOF setting, we recommend setting the date printing with the DPOF print in advance. (P107) The recording date can be printed by selecting [DPOF PICTURE] to start printing.



- Do not disconnect the USB connection cable when the cable disconnection warning icon [⚠] is indicated.
- When the [●] indication lights in orange during printing, the camera is receiving an error message from the printer. Make sure there is no malfunction on the printer after finishing printing.
- If the printer does not support TIFF printing, the JPEG picture created when the quality is set to [TIFF] is printed.
- If the printer does not support RAW printing, the JPEG picture created when the quality is set to [RAW] is printed.
- If no JPEG picture is created when the quality is set to [RAW] or [TIFF], printing may not be possible.
- In DPOF print, if the total number of prints or the number of printed pictures is high, pictures may be printed several times. (The indication of the remaining number of prints is different from the setting, however, this is not a malfunction.)
- The setting on the printer may have priority over the setting on the camera in the date print. Also check the date print setting on the printer.
- If the printer does not support date printing, the date cannot be printed on the picture.

■ Layout printing

• When printing a picture several times on 1 sheet of paper

For example, if you want to print a picture 4 times on 1 sheet of paper, set [PAGE LAYOUT] to [4x4] and then set the number of prints to 4 for the picture on [NUM. OF PRINTS].

• When printing different pictures on 1 sheet of paper (only in DPOF printing)

For example, if you want to print 4 different pictures on 1 sheet of paper, set [PAGE LAYOUT] to [4x4] and then set the number of prints to 1 on [COUNT] in DPOF print setting (P106) for each of the 4 pictures.

Using the Remote Shutter

The remote shutter (DMW-RS1; optional) works similar to the shutter button on the camera. You can avoid jitter (camera shake) when using a tripod.

1 Connect the remote shutter to the [REMOTE] socket on the camera firmly.

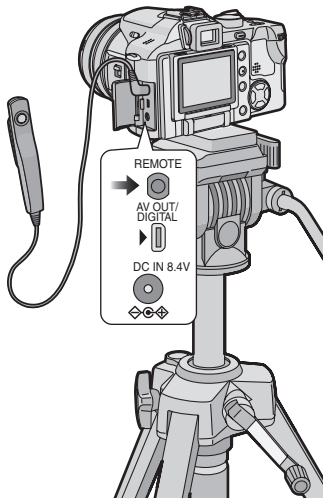

- You cannot operate the camera with the remote shutter in the following cases.
 - When the power save mode is canceled
 - When you determine the part to be trimmed (P111)
 - When you determine the aspect ratio conversion (P113)

2 Focus on the subject and take a picture.

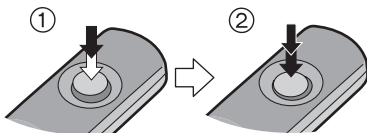

- ①: Press the shutter button halfway to focus.
- ②: Press the shutter button fully to take the picture.

Using the MC Protector/ND Filter

The MC protector (DMW-LMC55; optional) is a transparent filter which affects neither the colors nor the amount of light, so it can always be used to protect the camera's lens.

The ND filter (DMW-LND55; optional) reduces the amount of light to approximately 1/8th (equal to adjusting the aperture value 3 increments) without affecting the color balance.

1 Remove the lens cap.

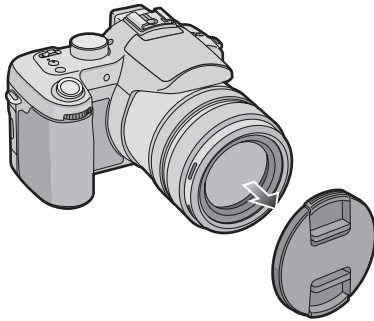

2 Attach the MC protector ① or the ND filter ②.

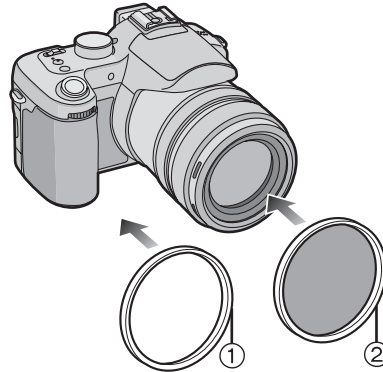

- You cannot attach the MC protector and the ND filter at the same time.
- Do not hold the MC protector/ ND filter too tightly.
- When taking pictures with the flash using the MC protector or ND filter, vignetting effect may occur.
- If the MC protector/ND filter are dropped, they may be destroyed. Be careful not to drop them when attaching them to the camera.
- You can attach the lens hood when the MC Protector and ND Filter are attached.
- Detach the MC Protector and ND filter before attaching the conversion lens.
- **MC**="Multi-coated"
- **ND**="Neutral Density"

Screen Display

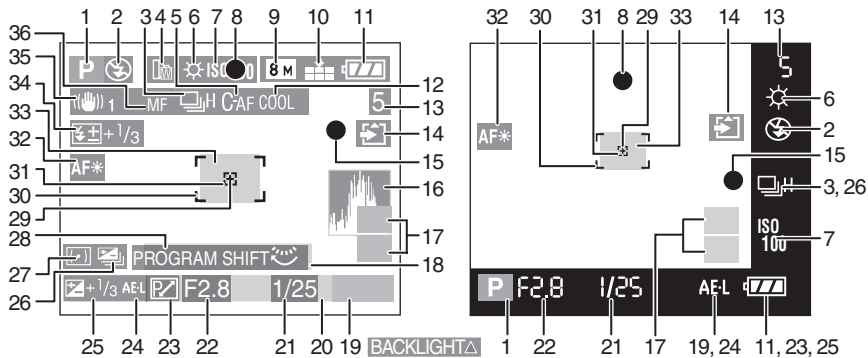

■ In recording

- 1 Recording mode
- 2 Flash mode (P49)
- 3 Burst (P57)
U: Audio recording (P69, 87)
- 4 Conversion lens (P95)
- 5 Continuous AF (P90)
- 6 White balance (P82)
- 7 ISO sensitivity (P84)
- 8 Focus (P37)
- 9 Picture size (P85)
- 10 Quality (P86)
 In Motion picture mode (P69)
30FPS / 10FPS / 30FPS / 10FPS
VGA / VGA / VGA / VGA
Jitter: Jitter alert (P39)
- 11 Battery indication (P13)
- 12 Color effect (P91)
- 13 Picture/Time remain
 In Motion picture mode: e.g. 11S
- 14 Card access indication (P16)
- 15 Recording state
- 16 Histogram (P30)
- 17 Zoom (P33) / 2X Digital zoom (P34) / 1X Extended optical zoom (P34)
- 18 Age (P75)
 • This is displayed for about 5 seconds when turning on the camera in [BABY], setting the clock and birthday,

and after switching from other modes to [BABY].

- 19 Operation for backlight compensation (P43)
- 20 Current date and time (P20)
 • This is displayed for about 5 seconds when turning the camera on, setting the clock and after switching from the playback mode to the recording mode.
- 21 Shutter speed (P37)
- 22 Aperture value (P37)
- 23 Program shift indication (P39)
AEL: AE lock (P40)
- 24 Backlight compensation (P43)
- 25 Exposure compensation (P54)
- 26 Auto bracket (P55)
- 27 Metering mode (P87)
- 28 Program shift setting indication (P39)
- 29 Spot metering target (P87)
- 30 AF area (P37)
- 31 Spot AF area (P88)
- 32 AF assist lamp (P90)
- 33 Self-timer (P53) 10
- 34 Flash output adjustment (P51)
- 35 Optical image stabilizer (P56)
- 36 MF indication (P46) / AF AF MACRO indication (P45)

Others

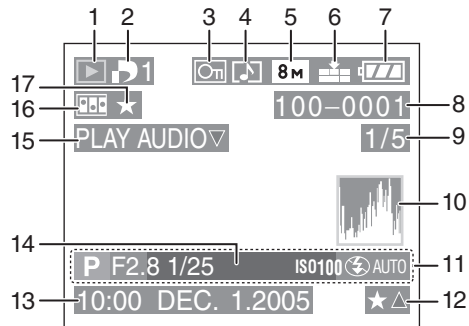

■ In playback

- | | |
|--|--|
| <p>1 Playback mode</p> <p>2 Number of DPOF prints (P106)</p> <p>3 Protected picture (P108)</p> <p>4 Picture with audio/Motion pictures (P100)</p> <p>5 Picture size (P85)</p> <p>6 Quality (P86)</p> <p style="padding-left: 20px;">In Motion picture mode (P69)</p> <p style="padding-left: 20px;"> 30fps / 10fps / 30fps / 10fps
 VGA / VGA / QVGA / QVGA </p> <p>7 Battery indication (P13)</p> <p>8 Folder/File number (P119)</p> <p>9 Page number/Total pictures</p> <p>10 Histogram (P30)</p> <ul style="list-style-type: none"> • It will be displayed when the [DISPLAY] button is pressed. | <p>11 Recording information (Recording mode/Aperture value/ Shutter speed/ISO sensitivity/Flash mode/White balance)</p> <ul style="list-style-type: none"> • It will be displayed when the [DISPLAY] button is pressed. <p>12 Favorites settings (P103)</p> <p>13 Recorded date and time</p> <p>14 Age (P75)</p> <p>15 Audio playback (P100)</p> <p style="padding-left: 20px;"> PLAY MOTION
 PICTURE ▾ : In Motion picture mode </p> <p>16 Flip animation (P92)</p> <p>17 Favorites (P103)</p> |
|--|--|

Cautions for Use

■ Optimal Use of the Camera

When carrying the camera, take care not to drop or cause impact to it.

- The lens or the outer case may be destroyed by the strong shock, and it causes a malfunction of the camera.

Keep the camera away from magnetised equipment (such as a microwave oven, TV, video game equipment, etc.).

- If you use the camera on or near a TV, pictures and sounds may be disrupted due to electromagnetic wave radiation.
- Do not use the camera near a cell phone because doing so may cause noise to adversely affect the pictures and sounds.
- Recorded data may be damaged, or pictures may be distorted by strong magnetic fields created by speakers or large motors.
- Electromagnetic wave radiation generated by a microprocessor may adversely affect the camera, causing the disturbance of pictures and sounds.
- If the camera is affected by magnetically charged equipment and does not function properly, turn the camera off and remove the battery or disconnect the AC adaptor (DMW-CAC1; optional) and then insert the battery or connect the AC adaptor again. Thereafter, turn the camera on.

Do not use the camera near radio transmitters or high-voltage lines.

- If you record near radio transmitters or high-voltage lines, recorded pictures or sounds may be adversely affected.

Make sure to use the supplied cords and cables. If you use optional accessories, use the cords and the cables supplied with them.

Do not extend the cords and the cables.

Do not spray insecticides or volatile chemicals onto the camera.

- If the camera is sprayed with such chemicals, the camera body may be damaged and the surface finish may peel off.
- Do not keep rubber or plastic products in contact with the camera for a long period of time.

Do not use benzine, thinner or alcohol for cleaning the camera.

- Before cleaning the camera, remove the battery or disconnect the AC adaptor (DMW-CAC1; optional) from the electrical outlet.
- The camera body may be deformed and the surface finish may peel off.
- Wipe the camera with a soft, dry cloth. To remove stubborn stains, wipe with a cloth that is soaked in a detergent diluted with water and afterward finish wiping with a dry cloth.
- When there is dirt or dust on the zoom ring or the focus ring, wet a cloth with water, wring it well, then use it to wipe off the dirt or dust.
- If you use a chemical cloth, follow the instructions that come with the cloth.
- In case rain or other sources of water splash onto the camera, wet a soft cloth with tap water, wring it well, and use it to wipe the camera body carefully. Then wipe it again with a dry cloth.

■ Battery

The battery is a rechargeable lithium ion battery. Its ability to generate power is based upon the chemical reaction that takes place inside it. This reaction is susceptible to the surrounding temperature and humidity, and, if the temperature is too high or too low, the operating time of the battery will be shorter.

After use, be sure to remove the battery.

When you go out, bring charged spare batteries.

- Be aware that the operating time of the battery will become shorter in low temperatures such as outdoors at a ski resort.
- When you travel, be sure to prepare the supplied charger to charge the battery on the spot.

Dispose of an unusable battery.

- The battery has a limited life.
- Do not throw the battery into fire because it may cause an explosion.
- An unusable battery should be discarded in accordance with battery recycling laws. For information you can call the RBRC hotline at 1-800-822-8837.

Do not allow the battery terminals to come in contact with metal objects (such as necklaces, hairpins, etc.).

- This can result in a short circuit or heat generation and, if you touch the battery in this condition, you may be badly burned.

If you drop the battery accidentally, check to see if the battery body and terminals are damaged.

- Inserting a damaged battery in the camera will damage the camera.

■ Charger

- If you use the charger near a radio, radio reception may be disturbed. Keep the charger 1 m (3.28 feet) or more away from radio.
- When the charger is in use, it may generate whirring sounds. However, this is not a malfunction.
- After use, be sure to disconnect the charger from the electrical outlet. (If it is left connected, a minute amount of current is consumed.)
- Keep the terminals of the charger and battery clean.

■ Card

Do not leave the card in places where there is high temperature or direct sunlight, or where electromagnetic waves or static electricity are easily generated.

Do not bend or drop the card.

- The card may be damaged or the recorded content may be damaged or erased.
- Store the card in the card case or the storage bag after use and when you store or carry the card.
- Do not allow dirt, dust or water to enter the terminals on the back of the card and do not touch the terminals with your fingers.

Message Display

Confirmation messages or error messages will be displayed on the screen in some cases.

Major messages are described below as examples.

[THIS MEMORY CARD IS PROTECTED]

Unlock [LOCK] of the Write-Protect switch on the SD Memory Card. (P16)

[NO VALID PICTURE TO PLAY]

Play back after recording or after inserting a card with a recorded picture.

[THIS PICTURE IS PROTECTED]

After canceling the protect setting, delete or overwrite the picture.

[THIS PICTURE CANNOT BE DELETED]/[SOME PICTURES CANNOT BE DELETED]

The pictures not based on the DCF standard cannot be deleted.

If you want to delete, format the card after saving necessary data on a PC or elsewhere.

[CANNOT BE SET ON THIS PICTURE]/[CANNOT BE SET ON SOME PICTURES]

If the pictures are not based on the DCF standard, the DPOF print cannot be set.

[NO ADDITIONAL DELETE SELECTIONS CAN BE MADE]

You have exceeded the number of pictures that can be set at once with [MULTI DELETE]. Once delete the selected pictures and then repeat deleting multiple pictures.

More than 999 favorites have been set.

[MEMORY CARD ERROR FORMAT THIS CARD?]

The format of the card cannot be recognized by the camera. Format the card again with the camera after saving necessary data on a PC or elsewhere.

[PLEASE TURN CAMERA OFF AND THEN ON AGAIN]

This message appears when the camera does not operate properly. Turn the camera off and on. If the message persists, contact the dealer or your nearest servicenter.

[MEMORY CARD ERROR PLEASE CHECK THE CARD]

Failed access to the card.
Insert the card again.

**[READ ERROR
PLEASE CHECK THE CARD]**

Data reading error.

Be sure that the card is inserted securely and then play it back again.

**[WRITE ERROR
PLEASE CHECK THE CARD]**

Data writing error.

Turn the camera off and remove the card. Then insert the card and turn the camera on again. Be sure that the camera is turned off before removing or inserting the card to avoid damage.

**[MOTION RECORDING WAS
CANCELLED DUE TO THE LIMITATION
OF THE WRITING SPEED OF THE
CARD]**

- When you set the picture quality to [30fpsVGA], we recommend using a high speed SD Memory Card with "10 MB/s" or greater displayed on the package.
- Depending on the number of pictures, type of card and number of pictures deleted, recording may stop in the middle when you are recording. If something like this happens, clean-up may be effective. We recommend you clean up the card using the camera in advance. (P114)

[A FOLDER CANNOT BE CREATED]

A folder cannot be created because the card is full.

Format the card after deleting unnecessary data or saving necessary data on a PC or elsewhere.

Troubleshooting

If you put the menu back to the settings at the time of purchase, the conditions may be improved.

Carry out the [RESET] in the [SETUP] menu. (P24)

■ Battery and the power source

1: The camera cannot be operated even when it is turned on.

- Is the battery inserted correctly?
- Is the battery sufficiently charged?
 - Use a battery that has been sufficiently charged.

2: The camera is turned off immediately even after it is turned on.

- Is the battery charge insufficient to operate the camera?
 - Use a battery that has been sufficiently charged.
-

■ Recording

1: The picture cannot be recorded.

- Is the card inserted?
- Is the mode dial correctly set?
- Is there any memory capacity left on the card?
 - Before recording, delete some pictures.

2: The subject is not focused properly.

- The focus range varies depending on the recording mode.
 - Rotate the mode dial to set to the proper mode for the distance to the subject.
- Is the subject out of the focus range? (P38)
- When you cannot focus on the subject even if you tried many times, turn the camera off once and turn it on again.

3: The recorded picture is blurred.

- When taking a picture especially in dark places, the shutter speed becomes slow and the optical image stabilizer function may not work properly. In this case, we recommend holding the camera with both hands firmly to take pictures. When you take pictures with slow shutter speed, we recommend using a tripod and the self-timer (P53) for taking pictures.

4: The recorded picture is whitish. The lens is dirty.

- The picture can become whitish if there is dirt e.g. fingerprints on the lens. When the lens is dirty, turn the camera on and lightly wipe the surface of the lens with a soft dry cloth.

5: Motion picture recording stops in the middle.

- Are you using a MultiMediaCard?
 - This unit does not support MultiMediaCard.
 - When you set the picture quality to [30fpsVGA], we recommend using a high speed SD Memory Card with “10 MB/s” or greater displayed on the package.
 - Depending on the number of pictures, type of card and number of pictures deleted, recording may stop in the middle when you are recording. If something like this happens, clean-up may be effective. We recommend you clean up the card using the camera in advance. (P114)
-

■ LCD monitor
1: The brightness of the screen becomes dark or bright for a moment.

- This phenomenon appears when pressing the shutter button halfway to set the aperture value and does not affect the recorded pictures.

2: The picture is not displayed on the LCD monitor.

- Does the picture appear on the Viewfinder?
– Press the [EVF/LCD] button to switch to LCD monitor display.

3: The screen is too bright or dark.

- Adjust the brightness of the screen.

4: Some pixels are inactive or always lit on the LCD monitor.

- These pixels do not affect the recorded pictures.
This is not a malfunction.

5: Noise appears on the LCD monitor.

- In dark places, noise may appear to maintain the brightness of the LCD monitor.
This does not affect the pictures you are recording.



6: A vertical line appears on the LCD monitor.

- This is called smear. It is specific to CCD, not a malfunction. It appears when the subject has a bright part. Horizontal line distortion may also appear around the smear. It is recorded on motion pictures, but not recorded on still pictures.

7: Distortion in the LCD monitor.

- When holding the edge of the LCD monitor, there may be some distortion, however this is not a malfunction. Moreover, this has no affect on the taken pictures or playback.
-

■ Flash
1: Flash is not activated.

- Is the flash closed?
– Slide the [ OPEN] lever to open the flash.
- In motion picture mode [] and [SCENERY] (P73), [NIGHT SCENERY] (P74), [FIREWORKS] (P77) or [STARRY SKY] (P79) in scene mode, the flash setting is fixed to Forced OFF [] even if the flash is opened.

2: The flash is activated 2 times.

- When you select AUTO/Red-eye reduction [], the first flash is activated for red-eye prevention on the subject (red-eye phenomenon) before actually recording pictures. After the first flash, the flash is activated again for recording.
-

■ Playback
1: Pictures being played are rotated and displayed in an unexpected direction.

The camera has a function to automatically rotate and display pictures recorded by holding the camera vertically.

(If you take pictures aiming the camera up or down, the camera may recognize that it is held vertically.)

- When [ROTATE DISP.] (P104) is set to [OFF], you can display the pictures without being rotated.
- You can rotate pictures with [ROTATE] function (P105).

2: The picture is not played back.

- Is the mode dial set to playback []?
- Is the card inserted?
- Is there a picture in the card?

Others

3: The picture played back looks rough. Noise appears on the picture.

- Is the ISO sensitivity is high or is the shutter speed slow?
 - Decrease the ISO sensitivity. (P84)
 - Have you set [NOISE REDUCTION] in [PICT.ADJ.] to [HIGH] or items other than [NOISE REDUCTION] to [LOW]? (P92)
 - Take pictures in bright places.

4: The folder number and the file number are displayed as [—] and the screen may turn black.

- Is the picture edited with a PC or recorded with the digital camera other than Panasonic?

This may also result if the battery is removed immediately after recording or by recording with the exhausted battery.

 - In order to delete the pictures mentioned above, format the data. (P115) (Once formatted, all the data including the other pictures cannot be restored. Confirm carefully to format.)

■ **TV, PC and printer**

1: The picture does not appear on the television.

- Is the camera connected to the TV correctly?
- Set the TV input to external input mode.

2: When connecting to a PC, pictures cannot be transferred.

- Is the camera connected to the PC correctly?
- Is the camera recognized by the PC correctly?
- Set [USB MODE] to [PC]. (P117)

3: The card is not recognized by the PC.

- Disconnect the USB connection cable and then connect it again with the card inserted into the camera.

4: The pictures cannot be printed with the camera connected to printers.

- Is the printer supporting PictBridge?
 - You cannot print pictures with printers which do not support PictBridge (P121).
- Set [USB MODE] to [PictBridge (PTP)]. (P117)

5: The ends of the pictures are cut at printing.

- When using the printer with a trimming feature or other feature which cuts out both edges of the pictures, cancel the feature for printing. The feature depends on the printer used. (Refer to the operating instructions of the printer for details.)
- When you order photo studios to print pictures, ask the photo studio if the pictures can be printed with both ends.

6: The display areas on the TV screen and the camera's LCD monitor are different.

With some TV models, the area display is smaller so the top and bottom or left and right of the picture may appear cut off when the picture is displayed. This is not a malfunction. In this case, check the picture on the camera's LCD monitor.

■ **Others**

1: Unreadable language was selected by mistake.

- Press the [MENU] button and select [] icon on the [] [SETUP] menu to set the desired language.

2: The setting for the auto review function is disabled.

- Is the camera in burst mode (P57), auto bracket (P55) or motion picture mode [] (P69), or is [AUDIO REC.] set to [ON] (P87)?
 - In these cases, you cannot set the auto review function in the [SETUP] menu.

Others

3: A certain part of the picture blinks.

- This appears due to the highlight display function which shows white saturated areas. (P29)

4: When the shutter button is pressed halfway, a red lamp sometimes turns on.

- In dark places, the AF assist lamp (P90) lights red to make it easier to focus on a subject.

5: The camera will make sounds caused by internal mechanical movement when it is shaken.

- The sound arises when the lens moves. This is not a malfunction.

6: The AF assist lamp does not turn on.

- Is [AF ASSIST LAMP] on the [REC] mode menu set to [ON]?
- Are you taking pictures in dark places?
– The AF assist lamp does not turn on in bright places.
- The AF assist lamp does not turn on when [SCENERY] (P73), [NIGHT SCENERY] (P74), [FIREWORKS] (P77), or [PANNING] (P80) in scene mode is selected.

7: The camera is getting warmer.

- The surface of the camera may get warmer during use. This does not cause a problem with the performance or quality of the camera.

8: When the zoom ring is rotated, the camera makes a noise.

- When the zoom function is activated, you may hear some sound from the camera or the camera may shake. However, it is not a malfunction.

9: The lens clicks.

- When brightness has changed due to the zoom or the movement of the camera or other, the lens may click and the picture on the screen may be drastically changed, however, the pictures are not affected.

The sound is caused by automatic adjustment of the aperture. It is not a malfunction.

10: The clock setting is reset.

- If you do not use the camera for a long time, the clock setting may be reset. When the message [PLEASE SET THE CLOCK] appears, set the clock again.
- When you take a picture before setting the clock, [0:00 0. 0. 0] is recorded.

11: Colors that were actually not around the subject appear on the picture.

- On the camera, color shift may appear by the characteristic of the lens. This is not a malfunction.

12: The file numbers are not recorded consecutively.

- When you perform an operation after taking a certain action, the pictures may be recorded in folders with different numbers from the ones used prior to the operation. (P119)

13: The file numbers are recorded in ascending order.

- If the battery is inserted or removed when the camera is not turned off, the recorded folder numbers are lost. However if you turn the camera on again and record pictures, the recorded folder numbers are different from the prior recorded folder numbers.

Specifications

Digital Camera:	Information for your safety
Power Source:	DC 8.4 V
Power Consumption:	2.1 W (When recording with LCD Monitor) 2.0 W (When recording with Viewfinder) 1.2 W (When playing back with LCD Monitor) 1.1 W (When playing back with Viewfinder)
Camera Effective pixels:	8,000,000 pixels
Image sensor:	1/1.8" CCD, total pixel number 8,320,000 pixels Primary color filter
Lens:	Optical 12× zoom, f=7.4 mm to 88.8 mm (35 mm film camera equivalent: 35 mm to 420 mm)/F2.8 to F3.7
Digital zoom:	Max. 4×
Focus:	Normal/AF MACRO/Manual/Macro, 9-area-focusing/ 3-area-focusing (High speed)/1-area-focusing (High speed)/ 1-area-focusing/Spot-focusing
Focus range:	AF: 30 cm (0.98 feet) (Wide)/2 m (6.56 feet) (Tele) to ∞ AF MACRO/MF: 5 cm (0.16 feet) (Wide)/ 2 m (6.56 feet) (Tele) to ∞
Shutter system:	Electronic shutter+Mechanical shutter
Burst recording	
Burst speed:	3 frames/second (High speed), 2 frames/second (Low speed), Approx. 2 frames/second (Unlimited)
Number of recordable pictures:	Max. 9 frames (Standard), max. 5 frames (Fine), Depends on the remaining capacity of the card. (Unlimited) (Performance in burst recording is only with SD Memory Card. MultiMediaCard performance will be less.)
Motion picture recording:	640×480 pixels/320×240 pixels (30 or 10 frames/second with audio. The maximum recording time depends on the capacity of the card.)
ISO sensitivity:	AUTO/80/100/200/400
Shutter speed:	60 to 1/2000th [STARRY SKY] mode: 15 seconds, 30 seconds, 60 seconds
White balance:	AUTO/Daylight/Cloudy/Halogen/Flash/White set1/White set2
Exposure (AE):	Program AE (P)/Aperture-priority AE (A)/ Shutter-priority AE (S)/Manual exposure (M) Exposure compensation (1/3 EV Step, -2 EV to +2 EV)
Metering mode:	Multiple/Center weighted/Spot
LCD monitor:	2.0" low-temperature polycrystalline TFT LCD (235,000 pixels) (field of view ratio about 100%)
Viewfinder:	Color LCD Viewfinder (235,000 pixels) (field of view ratio about 100%) (with diopter adjustment -4 to +4 diopter)
Flash:	Built-in pop up flash Flash range: (ISO AUTO) Approx. 30 cm (0.98 feet) to 7.0 m (23.0 feet) (Wide)

Others

AUTO, AUTO/Red-eye reduction, Forced ON (Forced ON/Red-eye reduction), Slow sync./Red-eye reduction, Forced OFF

Microphone: Monaural
Speaker: Monaural
Recording media: SD Memory Card/MultiMediaCard

Picture size
Still picture: When the aspect ratio setting is [4:3]
3264×2448 pixels, 2560×1920 pixels, 2048×1536 pixels,
1600×1200 pixels, 1280×960 pixels
When the aspect ratio setting is [16:9]
3072×1728 pixels, 1920×1080 pixels
When the aspect ratio setting is [3:2]
3248×2160 pixels, 2560×1712 pixels, 2048×1360 pixels,
640×480 pixels/320×240 pixels
Motion pictures: Fine/Standard/TIFF/RAW

Quality:
Recording file format
Still Picture: JPEG (Design rule for Camera File system, based on Exif 2.2 standard)/TIFF (RGB), DPOF corresponding
Picture with audio: JPEG (Design rule for Camera File system, based on Exif 2.2 standard)+640×480 pixels
QuickTime (picture with audio)
Motion pictures: QuickTime Motion JPEG (motion pictures with audio)

Interface
Digital: USB 2.0 (Full Speed)
Analog video/audio: NTSC/PAL Composite (Switched by menu),
Audio line output (monaural)

Terminal
REMOTE: ϕ 2.5 mm jack
AV OUT/DIGITAL: Dedicated jack (8 pin)
DC IN: type 3 jack
Dimensions: 140.75 mm (W)×85.5 mm (H)×138.1 mm (D) (5 9/16" (W)×
3 3/8" (H)×5 7/16" (D)) (excluding the projection part)
Mass: Approx. 674 g/23.8 oz
(excluding Memory Card and battery)
Approx. 740 g/26.1 oz (with Memory Card and battery)
Operating Temperature: 0 °C to 40 °C (32 °F to 104 °F)
Operating Humidity: 10% to 80%

Battery Charger
(Panasonic DE-993B): Information for your safety







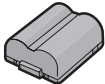
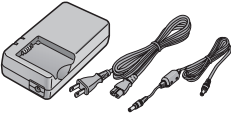

Input:	110 to 240 V~ 50/60 Hz, 0.15 A
Output:	CHARGE 8.4 V===0.43 A

Equipment mobility: Movable

Battery Pack (lithium-ion)
(Panasonic CGR-S006A): Information for your safety

Voltage/capacity:	7.2 V, 710 mAh
--------------------------	----------------

Digital Camera Accessory System

Accessory#	Figure	Description
CGR-S006A		Lithium Ion Battery
DMW-CAC1		Battery Charger/AC Adaptor
DMW-LND55		ND Filter
DMW-LMC55		MC Protector
RP-SDK02GU1A RP-SDK01GU1A RP-SDK512U1A RP-SD512BU1A RP-SDH256U1A RP-SD256BU1A RP-SD128BU1A RP-SD064BPPA RP-SD032BPPA		2 GB SD Memory Card 1 GB SD Memory Card 512 MB SD Memory Card 512 MB SD Memory Card 256 MB SD Memory Card 256 MB SD Memory Card 128 MB SD Memory Card 64 MB SD Memory Card 32 MB SD Memory Card
BN-SDCAPU/1B		SD USB Reader/Writer (compatible with MultiMediaCard)
BN-SDABPU/1B		SD PC Card Adaptor (compatible with MultiMediaCard)
DMW-FL28		External Flash
DMW-RS1		Remote Shutter

- Please refer to pages 13, for details on the battery charging time and the number of recordable pictures.
- NOTE: Accessories and/or model numbers may vary by country. Please consult your local dealer.

Others

Digital Camera Accessory Order Form

(For USA Customers)

Please photocopy this form when placing an order.

1. Digital Camera Model # _____

2. Items Ordered

Accessory #	Description	Price Each	Quantity	Total Price
Subtotal				
Your State & Local Sales Tax				
Shipping & Handling				6.95
Total Enclosed				

3. Method of payment (check one)

- Check of Money Order enclosed (NO C.O.D.SHIPMENTS)
- VISA Credit Card # _____
- MasterCard Expiration Date _____
- Discover Customer Signature _____

Make Check or Money Order to: PANASONIC ACCESSORIES

(Please do not send cash)

4. Shipping information (UPS delivery requires complete street address)

Ship To:

Mr.

Mrs.

Ms.

First _____ Last _____

Phone#:

Day () _____

Street Address _____

Night () _____

City _____ State _____ Zip _____

TO OBTAIN ANY OF OUR DIGITAL CAMERA ACCESSORIES YOU CAN DO ANY OF THE FOLLOWING:

VISIT YOUR LOCAL PANASONIC DEALER

OR

CALL PANASONIC'S ACCESSORY ORDER LINE AT 1-800-332-5368

[6 AM-5 PM M-F, 6 AM-10:30 AM SAT, PACIFIC TIME]

OR

MAIL THIS ORDER TO: PANASONIC SERVICES COMPANY ACCESSORY ORDER OFFICE

20421 84th Avenue South Kent, WA. 98032

In CANADA, please contact your local Dealer for more information on Accessories.

140

VQT0R81

Others

Request for Service Notice (For USA Only)

Please photocopy this form when making a request for service notice.

In the unlikely event this product needs service.

Request for Service Notice: (USA Only)

- Please include your **proof of purchase.**
(Failure to do so will delay your repair.)
- To further speed your repair, please provide an explanation of what wrong with the unit and any symptom it is exhibiting.

Mail this completed form and your Proof of Purchase along with your unit to:
Panasonic Services Company
1705 N. Randall Road
Elgin, IL. 60123-7847
Attn: Digital Camera Repair

Others

Limited Warranty (For USA Only)

PANASONIC CONSUMER
ELECTRONICS COMPANY,
DIVISION OF PANASONIC
CORPORATION OF NORTH
AMERICA

One Panasonic Way, Secaucus, New
Jersey 07094

PANASONIC PUERTO RICO, INC.
Ave. 65 de Infantería, Km. 9.5, San
Gabriel Industrial Park, Carolina,
Puerto Rico 00985

Panasonic Digital Still Camera Limited Warranty

Limited Warranty Coverage

If your product does not work properly because of a defect in materials or workmanship, Panasonic Consumer Electronics Company or Panasonic Puerto Rico, Inc. (collectively referred to as “the warrantor”) will, for the length of the period indicated on the chart below, which starts with the date of original purchase (“warranty period”), at its option either (a) repair your product with new or refurbished parts, or (b) replace it with a new or refurbished product. The decision to repair or replace will be made by the warrantor.

PRODUCT OR PART NAME	PARTS	LABOR
DIGITAL STILL CAMERA (EXCEPT ITEMS LISTED BELOW)	1 (ONE) YEAR	90 (NINETY) DAYS
CCD	6 (SIX) MONTHS	90 (NINETY) DAYS
RECHARGEABLE BATTERY PACK (IN EXCHANGE FOR DEFECTIVE BATTERY PACK)	90 (NINETY) DAYS	NOT APPLICABLE
SD MEMORY CARD (IN EXCHANGE FOR DEFECTIVE SD CARD)	90 (NINETY) DAYS	NOT APPLICABLE

During the “Labor” warranty period there will be no charge for labor. During the “Parts” warranty period, there will be no charge for parts. You must carry-in or mail-in your product during the warranty period. If non-rechargeable batteries are included, they are not warranted. This warranty only applies to products purchased and serviced in the United States or Puerto Rico. This warranty is extended only to the original purchaser of a new product which was not sold “as is”. A purchase receipt or other proof of the original purchase date is required for warranty service.

Others

Carry-In or Mail-In Service

For Carry-In or Mail-In Service in the United States call
1-800-272-7033.

For assistance in Puerto Rico call Panasonic Puerto Rico, Inc.
(787)-750-4300 or fax (787)-768-2910.

This warranty ONLY COVERS failures due to defects in materials or workmanship, and DOES NOT COVER normal wear and tear or cosmetic damage. The warranty ALSO DOES NOT COVER damages which occurred in shipment, or failures which are caused by products not supplied by the warrantor, or failures which result from accidents, misuse, abuse, neglect, mishandling, misapplication, alteration, faulty installation, set-up adjustments, misadjustment of consumer controls, improper maintenance, power line surge, lightning damage, modification, or commercial use (such as in a hotel, office, restaurant, or other business), rental use of the product, service by anyone other than a Factory Servicenter or other Authorized Servicer, or damage that is attributable to acts of God.

THERE ARE NO EXPRESS WARRANTIES EXCEPT AS LISTED UNDER "LIMITED WARRANTY COVERAGE". THE WARRANTOR IS NOT LIABLE FOR INCIDENTAL OR CONSEQUENTIAL DAMAGES RESULTING FROM THE USE OF THIS PRODUCT, OR ARISING OUT OF ANY BREACH OF THIS WARRANTY. (As examples, this excludes damages for lost time, travel to and from the servicer, loss of media or images, data or other memory content. The items listed are not exclusive, but are for illustration only.) **ALL EXPRESS AND IMPLIED WARRANTIES, INCLUDING THE WARRANTY OF MERCHANTABILITY, ARE LIMITED TO THE PERIOD OF THE LIMITED WARRANTY.**

Some states do not allow the exclusion or limitation of incidental or consequential damages, or limitations on how long an implied warranty lasts, so the exclusions may not apply to you.

This warranty gives you specific legal rights and you may also have other rights which vary from state to state. If a problem with this product develops during or after the warranty period, you may contact your dealer or Servicenter. If the problem is not handled to your satisfaction, then write to the warrantor's Consumer Affairs Department at the addresses listed for the warrantor.

PARTS AND SERVICE WHICH ARE NOT COVERED BY THIS LIMITED WARRANTY ARE YOUR RESPONSIBILITY.

Others

Customer Services Directory (For USA Only)

For Product Information, Operating Assistance, Literature Request, Dealer Locations, and all Customer Service inquiries please contact:

1-800-272-7033, Monday-Friday 8:30am-8pm EST.

Web Site: <http://www.panasonic.com/consumersupport>

You can purchase parts, accessories or locate your nearest servicer by visiting our Web Site.

Accessory Purchases:

Purchase Parts, Accessories and Instruction Books online for all Panasonic Products by visiting our Web Site at:

<http://www.pasc.panasonic.com>

or, send your request by E-mail to:

npcparts@us.panasonic.com

You may also contact us directly at:

1-800-332-5368 (Customer Orders Only)

Panasonic Services Company 20421 84th Avenue South, Kent, WA 98032

(6 am to 5 pm Monday - Friday; 6 am to 10:30 am Saturday; PST)

(Visa, MasterCard, Discover Card, American Express, Check)

Product Repairs

Centralized Factory Servicer

MAIL TO :

Panasonic Services Company

1705 N. Randall Road,

Elgin, IL 60123-7847

Attention: Digital Camera Repair

Please carefully pack and ship, prepaid and insured, to the Elgin Centralized Factory Servicer.

Customer's in Puerto Rico, please ship or carry in to location below ("Service in Puerto Rico").

Service in Puerto Rico

Panasonic Puerto Rico, Inc.:

Ave. 65 de Infantería, Km. 9.5, San Gabriel Industrial Park, Carolina, Puerto Rico 00985

Phone (787) 750-4300 Fax (787) 768-2910

As of November 2004

Index

A	E
AC Adaptor 118, 121	Exposure 41
Adjusting Flash Output 51	Exposure Compensation 54
AE Lock Button 40	Extended Optical Zoom 34
AF Assist Lamp 90	External Flash 97
AF Mode 88	External Flash Burst Mode 99
AF/AE Lock 38	EZ 32, 34, 85
Aperture-priority AE 64, 68	
Aspect Ratio 84	F
Aspect Ratio Conversion 113	File Number 23, 119, 128
Audio Dubbing 109	Fine 86
Audio Recording 69, 87	Fireworks Mode 77
Auto Bracket 55	Flip Animation 92
Auto Review 22	Focus 38
Auto White Balance 82	Folder Composition 119
	Folder Number 23, 119, 128
B	Food Mode 73
Baby Mode 75	Formatting 115
Backlight Compensation 43	
Brightness of the LCD Monitor/ Viewfinder 22	H
Built-in Flash 49	Highlight Display 24, 29
Burst Mode 57	Histogram 30
C	I
Candle light mode 76	ISO Sensitivity 84
Card 16	
Card Access Indication 16	J
Center Weighted 87	Jitter 39
Changing the Zoom Area 48	
Charger 130	L
Charging 13	Language setting 24
Clean Up 114	Layout 123
Clock Set 20, 23	LCD Monitor 25, 127
Color Effect 91	
Condensation 5	M
Continuous AF 90	Manual Exposure 66, 68
Conversion Lens 95	Manual Exposure Assistance 66
	Manual Focus 46
D	Mass Storage 117
Date Printing 107, 124	MC Protector 126
Deleting Pictures 62	Metering Mode 87
Demonstration of the Optical Image Stabilizer 56	MF Assist 23, 47
Digital Zoom 91	Mode Dial 36
Dioptr Adjustment 29	Monitor Priority 22, 29
Direction Detection Function 28	Motion Picture Mode 69
DPOF Print Setting 106	Multi Playback 60
	Multiple 87

Others

<hr/>		<hr/>	
N		S	
ND Filter	126	Scene Menu	24
Night Portrait Mode	74	Scene Mode	71
Night Scenery Mode	74	Scenery Mode	73
NO.RESET	23	Selecting the AF area	89
NTSC	24	Self-timer	53
Number of prints	122	Setting Favorites	103
Number of recordable pictures	13, 31	Setup Menu	21
<hr/>		Shutter sound	23
O		Shutter-priority AE	65, 68
One Shot AF	47	Slide Show	102
Operational sound	23	Snow Mode	78
Optical Image Stabilizer	56	Soft Skin Mode	76
Optical Zoom	33	Sports Mode	72
Out-of-frame Display	29	Spot	87
<hr/>		Spot-focusing	88
P		Standard	86
PAL	24	Starry sky mode	79
Panning Mode	80	<hr/>	
Paper Size	122	T	
Party Mode	77	Tele Conversion Lens	96
PC	117, 118	TIFF	86
PictBridge	117, 121	Trimming	111
Picture Adjustment	92	<hr/>	
Picture Quality Setting		U	
(Motion Picture Mode)	69	USB Connection Cable	117, 118, 121
Picture Size	31, 85	USB Mode	24, 117, 118, 121
Playback	59	<hr/>	
Playback Pictures on TV	116	V	
Playback Zoom	61	Video output	24, 116
Playing Back Motion Pictures	100	Viewfinder	25, 127
Portrait Mode	72	Volume of Speakers	23
Power Indicator	37	<hr/>	
Power Save	23	W	
Prefocus	48	White Balance	82
Program AE	37	White Balance Fine Adjustment	83
Program Shift	39	White Set	83
Protect	108	Wide Conversion Lens	96
PTP	117	<hr/>	
<hr/>		Numerics	
Q		1-area-focusing	88
Quality	86	1-area-focusing (high speed)	88
<hr/>		3-area-focusing (high speed)	88
R		9-area-focusing	88
RAW	86	<hr/>	
Recording Guide Line	29		
Remote Shutter	125		
Reset of setting	24		
Resizing	110		
Review	44		
Rotate	105		

Spanish Quick Use Guide/Guía rápida en español

Ésta es una visión de conjunto que trata del procedimiento para grabar y reproducir las imágenes con la cámara.

1 Cargue la batería.

- Cuando se envía la cámara, la batería está sin carga. Cárguela antes del uso.

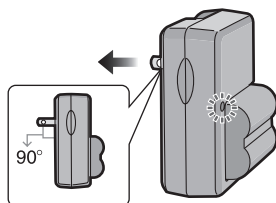

2 Inserte la batería y la tarjeta.

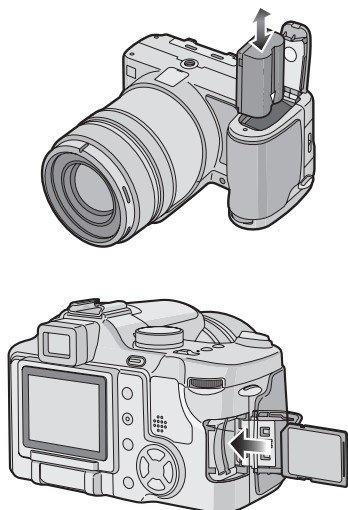

3 Encienda la cámara para tomar las imágenes.

- Ajuste el reloj.

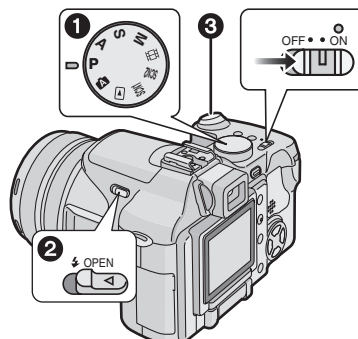

- 1 Ajuste el disco del modo a [P].
- 2 Abra el flash.
(Cuando usa el flash)
- 3 Pulse el botón del obturador para tomar las imágenes.

4 Reproduzca las imágenes.

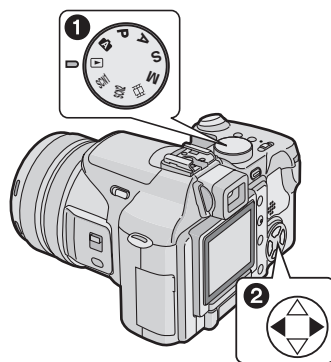

- 1 Ajuste el disco del modo a [▶].
- 2 Elija la imagen que quiere ver.



QuickTime and the QuickTime logo are trademarks or registered trademarks of Apple Computer, Inc., used under license.

**Panasonic Consumer Electronics Company,
Division of Panasonic Corporation of North America**

One Panasonic Way, Secaucus, NJ 07094

Panasonic Puerto Rico, Inc.

Ave. 65 de Infantería, Km. 9.5, San Gabriel Industrial Park, Carolina, Puerto Rico 00985

Panasonic Canada Inc.

5770 Ambler Drive, Mississauga, Ontario, L4W 2T3

© 2005 Matsushita Electric Industrial Co., Ltd.



VQT0R81
F0705Hy0(10000 (A)
©

